



**MODEL RL331X
AUTOMATED TELLER MACHINE
USER MANUAL**

TDN 07103-00222 Rev D. February 19, 2016

CORPORATE HEADQUARTERS

21405 B Street
Long Beach, MS 39560
Phone: (800) 259-6672
Fax: (228) 868-9445



COPYRIGHT NOTICE

© 2016 Triton. All Rights Reserved. TRITON logo is a registered trademark of Triton Systems of Delaware LLC.

DOCUMENT UPDATES

September 10, 2010 Original
February 24, 2012 Added HCDU dispenser.
May 19, 2014 Added Appendix G - T9 EPP Keypad
February 19, 2016 Added requiriements for Relative Humidity.

NOTICES

Copyright © 2014 Triton Systems of Delaware, LLC.

ALL RIGHTS RESERVED

This publication is protected by copyright and all rights are reserved. No part of it may be reproduced or transmitted by any means or in any form, without prior consent in writing from Triton Systems of Delaware, LLC.

The information in this publication has been carefully checked and is believed to be accurate. However, Triton Systems of Delaware, LLC assumes no responsibility for any inaccuracies, errors, or omissions that may be contained in this document. In no event will Triton Systems of Delaware, LLC be liable for direct, indirect, special, incidental, or consequential damages resulting from any defect or omission in this manual, even if advised of the possibility of such damages.

In the interest of continued product development, Triton Systems of Delaware, LLC reserves the right to make improvements in its documentation and the products it describes at any time, without notice or obligation.

TRADEMARK ACKNOWLEDGEMENTS

Microsoft Windows is a registered trademark of Microsoft Corporation in the United States and/or other countries. Triton Connect is a trademark of Triton Systems of Delaware, LLC. VISA® is a registered trademark of VISA of the United States and other countries.

CONTENTS

SECTION 1 - INTRODUCTION	1-1
WHAT'S IN THIS MANUAL.....	1-2
FEATURE HIGHLIGHTS / CHANGES.....	1-3
STANDARD FEATURES	1-4
SECTION 2 - BASIC OPERATION	2-1
INTRODUCTION	2-1
CONTROL PANEL LAYOUT.....	2-2
FUNCTION KEYPADS	2-3
MAIN KEYPAD	2-3
ON-SCREEN KEYPAD OPERATION.....	2-4
MENU-BASED OPERATION	2-5
CUSTOMER TRANSACTIONS.....	2-6
VOICE-ENABLED TRANSACTIONS	2-8
SECTION 3 - CASSETTE CLOSE / CASH REPLENISHMENT.....	3-1
INTRODUCTION	3-2
DISPENSING MECHANISMS.....	3-2
NOTE CONDITION	3-3
PREPARING NOTES.....	3-3
CASSETTE CLOSE PROCEDURES.....	3-4
REPLENISH CASSETTE(S).....	3-5
SCDU/HCDU	3-5
SDD.....	3-7
SECTION 4 - GENERAL MAINTENANCE.....	4-1
INTRODUCTION	4-2
REPLENISHING THE RECEIPT PAPER.....	4-2
CLEANING THE ENCLOSURE.....	4-5
CLEANING THE DISPLAY.....	4-5
CARD READER CLEANING.....	4-5

CONTENTS

APPENDIX A - SOFTWARE LICENSE AGREEMENTA-1

APPENDIX B - WARRANTY STATEMENTB-1

APPENDIX C - ELECTRONIC LOCKS.....C-1

APPENDIX D - MECHANICAL LOCKS.....D-1

APPENDIX G - T9 EPP KEYPAD.....G-1

SUPPLEMENT A - T7 T5 EPP BATTERY REPLACEMENT PROCEDURES.....SA-1

SUPPLEMENT B - KEY MANAGEMENT.....SB-1

THIS PAGE INTENTIONALLY LEFT BLANK

SECTION 1

INTRODUCTION



WHAT'S IN THIS MANUAL

The User manual describes the operating features of the Model RL331X series ATM and shows how to perform the procedures that would typically be performed by the owner or operator personnel.

The manual is divided into the following sections:

SECTION 1, INTRODUCTION. Summarizes the basic features of the Model RL331X series ATM.

SECTION 2, BASIC OPERATION. Describes the basic operation of the terminal:

- Control Panel Layout.
- Keypads (Function, Main, On-Screen)
- Menu-Based Operation
- Customer Transaction Process
- Voice-Enabled Transactions

SECTION 3, CASSETTE CLOSE / CASH REPLENISHMENT. Describes the menu functions for cassette close procedures. Cash replenishment steps for each dispenser and standards are covered as well.

SECTION 4, GENERAL MAINTENANCE. Describes normal preventative and corrective maintenance procedures appropriate for user personnel.

- Replenishing Receipt Paper
- Cleaning the Enclosure/Card Reader

APPENDIX A - SOFTWARE LICENSE AGREEMENT / COMPLIANCE STATEMENTS

APPENDIX B - WARRANTY STATEMENT

APPENDIX C - ELECTRONIC COMBINATION LOCKS

APPENDIX D - MECHANICAL COMBINATION LOCKS

SUPPLEMENT A - T7 T5 BATTERY REPLACEMENT PROCEDURES

IMPORTANT: Follow the instructions provided in SUPPLEMENT A of this manual for replacing the battery for the T7 & T5 PCI-EPP. Failure to follow the explicit instructions will permanently damage the keypad!

SUPPLEMENT B - T7 T5 KEY MANAGEMENT FUNCTIONS.

FEATURE HIGHLIGHTS

Important features of the RL331X series ATM are highlighted in the following list:

- Highly reliable, state-of-the-art operating system PC platform design. The RL331X uses Microsoft® Windows® CE 5.0 operating system with Triton's X2 technology. Supports Windows file formats for adding custom logos and advertisements. In addition, it features Triton's completely custom design X2 motherboard with integrated modem.
- Modular architecture eases troubleshooting and servicing.
- Front-access unit accommodates single cassette (SCDU or SDD,) and multi-cassette (HCDU)
 - Only one cabinet design, shallow, accommodates the dispenser mechanism offered.
 - Cabinet available in UL 291 Business Hours only. **Cash must be removed after hours.**
- 8.0" (203mm) widescreen color LCD display.
- T7 & T5 PCI-compliant EPP to comply with international encryption standards and Triple DES compliant.

FEATURE HIGHLIGHTS

- Easy to install (small footprint design makes placement easier) and configure terminal parameters by software.
- Supports communication types TCP/IP (standard), dial-up (56K baud Triton USB modem - integrated on motherboard): , and wireless optional.
(Note: For wireless option, please contact your account representative for more information).
- Multi-function, dip-style card reader supports magnetic stripe cards or “smart” cards that conform to the EMV standard. (Serial MCR Standard DIP [US] or IS65 EMV DIP [Canada ONLY])
- Graphics-capable 58 mm gravity-fed thermal printer designed for quiet operation. Prints receipts, coupons, and management reports. Cuts and presents receipt.
- Mechanical (standard) or electronic combination lock (optional).
- Supports remote setup, configuration, and monitoring via Triton Connect™ ATM monitoring software.
- Dispenses U.S. and international currency types.
- High-capacity electronic journal stores transaction details for later printout and analysis.
- Satisfies Americans with Disabilities Act (ADA) specifications for height and access; audio transactions for the visually impaired. Complies with UK accessibility guidelines (DDA) and California access compliance, Title 24.
- LED-backlit signage standard.

STANDARD FEATURES

- MANAGEMENT FUNCTIONS.** Enable extensive control and customization of the ATM’s operating parameters. See “**X-SCALE/X2 CONFIGURATION MANUAL**” on web site.
- PASSWORD PROTECTION.** Access to Management Functions and Key Management areas are protected with passwords.
- MAC ENCRYPTION SUPPORT.** Message Authentication Code (MAC) data encryption protocol. Provides increased protection for message traffic to and from the ATM. *Triple DES compliant.*
- SSL Support.** TCP/IP with Secure Socket Layer adds another level of ATM to Host communications security.
- PCI COMPLIANT ENCRYPTING PIN PAD (EPP) ENTRY DEVICE SUPPORT.** Secure EPP device encrypts the customer PIN during a transaction. *Triple DES and PCI compliant.*
- MULTI-LANGUAGE SUPPORT.** Enables the customer to select a preferred language (such as French or Spanish) for customer screens and receipts.

INTRODUCTION

- ❑ **TRANSACTION AND ACCOUNT TYPE CONFIGURATION.** Enables selection of transactions (transfers or balance inquiries) or accounts (savings or credit card) that will be presented to the customer. Does not affect availability of checking account withdrawal.
- ❑ **CASSETTE AND DAY CLOSE REPORTS.** Provide summary information about the number and type of transactions being performed by the ATM.
- ❑ **ELECTRONIC JOURNAL.** Stores the details of each transaction in solid-state memory. Journal data can be retrieved, printed, saved to an external storage device, or transferred to a remote Triton Connect™ computer.
- ❑ **AD SCREENS.** An Ad screen is a promotional or advertising graphic that is displayed on the LCD screen during idle periods. Ad screens are downloaded to the terminal by either using an external storage device (USB jumpdrive) or a remote Triton Connect™ computer. Text-only (non-graphic) ad screens can also be displayed.
- ❑ **RECEIPT PRINTER GRAPHICS.** This feature allows informational or promotional graphics to be printed on customer receipts. Graphics can be loaded from an external storage device or Triton Connect™.
- ❑ **MESSAGES.** Informational and promotional messages that are displayed to the customer on-screen or printed on receipts.
- ❑ **COUPONS.** Coupons can be printed by the receipt printer. Prizes may be awarded to customers based on random and/or withdrawal amount-based transactions. Coupon text can be entered locally or downloaded along with coupon graphics using Triton Connect™ software.
- ❑ **STATUS MONITORING.** The ATM can periodically transfer status information to the host processor. In addition, Triton Connect™ remote monitoring software can be used to view the journal, monitor operation and alarm conditions, update operating parameters, and reset the terminal.
- ❑ **UL 291 BUSINESS HOURS SERVICE.** Business hours cabinet means currency should be removed from the dispenser and stored in a safe location when the business is closed to the public.
- ❑ **FRONT-ACCESS CABINET.** Allows access to the dispensing mechanism and currency cassette from the control-panel side of the unit.
- ❑ **Relative Humidity Rating.** 20% - 80% for paper notes. 20% - 70% for palymer notes.

Weight of the RL331X (Approximate)	
Business Hours	Configuration
140 lbs 63 Kilos	Shallow cab Dispenser

THIS PAGE INTENTIONALLY LEFT BLANK

SECTION 2

BASIC OPERATION



INTRODUCTION

This section describes the basic operation of the terminal. The following topics are covered:

1. **CONTROL PANEL LAYOUT.** Describes the layout of the terminal's control panel.
2. **KEYPAD OPERATION.** Describes the use of the alphanumeric keypads.
3. **MENU-BASED OPERATION.** Gives a general overview of the terminal display interface.
4. **CUSTOMER TRANSACTIONS.** Summarizes the actions involved in typical customer transactions. In addition, the voice-enabled transactions feature is described.

CONTROL PANEL LAYOUT

The user interface of the terminal consists of the LCD screen, receipt chute, card reader, speaker, headphone jack (visually impaired), and 24 keys on three keypads. The Function keys are arranged in two four-key groups, one group on either side of the LCD display. The main keypad consists of 10 alphanumeric keys, two arrow keys and four large control keys, all located in a 16-key group beneath the LCD screen.

The main keypad and control keys have an integral raised Braille symbol to conform to the requirements of the Americans with Disabilities Act (Figure 2-1).



Figure 2-1. Control panel layout.

FUNCTION KEYS

The eight (8) keys, arranged in two four-key groups, are called screen function keys. A screen function key is only active when a corresponding function or menu option is present next to that key. The Function keys are designated F1 through F8, as shown in Figure 2-2.



Figure 2-2. Function key layout.

MAIN KEYPAD

The entry of numeric characters via the main keypad is straightforward: simply press the desired key. However, in certain Management Function screens it may be necessary to enter alphabetic characters, a procedure that's available with the On-Screen keypad, explained on next page.



Figure 2-3.
Alphanumeric
keypad.

ON-SCREEN KEYPAD OPERATION

To enter text characters into the dialog boxes that are displayed by the Management Functions, press the **F8** key to display the screen keyboard. Use the keys described below to navigate and enter required data. (see Figure 2-4)

- The Arrow keys (< and >), the <8> key - (**Up**), and the <0> key - (**Down**) navigate the keyboard.
- Press the <ENTER> key to select the highlighted key entry.
- Press the <CTRL> key to switch between upper and lower case characters.
- Press the <CANCEL> key to Exit the keyboard.
- Press the <CLEAR> key for the Backspace operation.
- Press the <1> key to reposition the keyboard to another location on the display.
- Press the <2> key to position the cursor on a new line.

Use arrow keys to navigate (8 = Up, 0 = Down) ENTER = Select, CANCEL = Exit, CLEAR = Backspace 1 = Reposition, 2 = New Line, Blank Key = Next Page	1	2	3	4	5	6	7	8	9	0	-	=
	q	w	e	r	t	y	u	i	o	p	[]
	a	s	d	f	g	h	j	k	l	;	'	\
	z	x	c	v	b	n	m	,	.	/	'	

Figure 2-4. On-screen keyboard.

MENU-BASED OPERATION

The terminal operates as a menu driven system. Messages and menu options presented on the LCD display screen guide the user's actions. The desired menu option is selected by pressing one of the keys located to the left and right of the display. For the purpose of security many screens time-out after a preset time interval, usually 30 seconds. The time-out length may vary depending on the function being performed.

When a screen time-out occurs, a screen is presented which asks the user if more time is needed. If the user chooses NO, the Customer Welcome screen will be presented. If YES is chosen, the user is returned to the function that was active prior to the time-out. If the user does not make a selection within an additional 30-second countdown period the terminal will automatically go to the Customer Welcome screen.

Ensure all procedures in the Installation Guide have been accomplished. The unit should be off, with the power cord and communications cable connected. Power on the unit by placing the power switch on the power supply to the on position. Shortly after the unit is turned on, the top menu will be displayed. An example top menu is shown in Figure 2-5. An Error Code of 246 WILL be displayed upon the first start up. You **MUST** change the master password before any other configuration operations will be allowed. From the top menu, you can either:

1. Activate the terminal to perform customer transactions by pressing the key next to **CUSTOMER TRANSACTIONS**.
2. Enter the terminal system management area by pressing the key next to **MANAGEMENT FUNCTIONS**.
Note: You will have to enter an appropriate password to view the Management Functions menu.

The master password is actually made up of two (2) parts, the ID and the password. The master ID is 00 and cannot be changed. What must be changed is the default master password for ID 00 of 1234.

- Management functions can be entered from the Top Menu screen upon startup (representative screen on the next page), or by pressing the "Blank Key" (lower right corner) and the number "1" at the same time.

- It will ask you to enter the ID and Password. Press 001234.

- It will then take you to the main management menu.

- Select 4 Password Maintenance / 1 Change User Password

- Enter the new password **ONLY**. You are user 00 and already logged in, so putting 00 here is not necessary. The new password can be 4-12 digits. Do not use birthdays, telephone numbers, social security numbers or the like. Make it something you can remember, but not so difficult as to be forgotten. Guard it closely. If the password is lost or forgotten, Triton can provide a reset for a charge.

If you will have additional people that will be accomplishing closes and replenishing cassettes, you may add them and provide passwords here. New users can be ID 01 - 99.

Refer to document 07100-00016 Configuration Manual for further terminal setup procedures.

Take this opportunity to change the lock combination. Refer to Appendix C or D for your lock. The same rules for combination numbers as passwords apply.

If you do not select a menu choice within 30 seconds the terminal will automatically default to the Customer Welcome screen (a benefit of this feature is that in the event of a power interruption the terminal will automatically begin accepting customer transactions shortly after power is restored).



Figure 2-5. Top menu screen.

CUSTOMER TRANSACTIONS

A customer begins a transaction by selecting from the Customer screen options. They insert their ATM card into the card reader of the terminal. The card must be inserted so that the magnetic stripe can be scanned by the card reader's sensor. If the customer inserts the card incorrectly, a warning message will be displayed, accompanied by several beeps to get their attention.

If there is a problem reading a card, make sure the customer is inserting the card correctly. Most problems are the result of inserting the card incorrectly.

Once the card has been read in successfully, a surcharge message, if applicable, may be displayed (the surcharge message may be displayed at the end of the customer's transaction selection). The customer must then enter their secret Personal Identification Number (PIN) code. Once the PIN has been entered, the transaction type and account are selected, and the desired amount of the transaction, if needed. The transaction will be processed, typically in a matter of seconds.

Figure 2-6 shows how ATM transactions are handled. If the transaction was processed successfully, the customer is prompted to retrieve the requested cash (for withdrawal transactions) and/or the applicable transaction receipt, as needed. If the transaction was declined, a short receipt indicating the problem is printed.

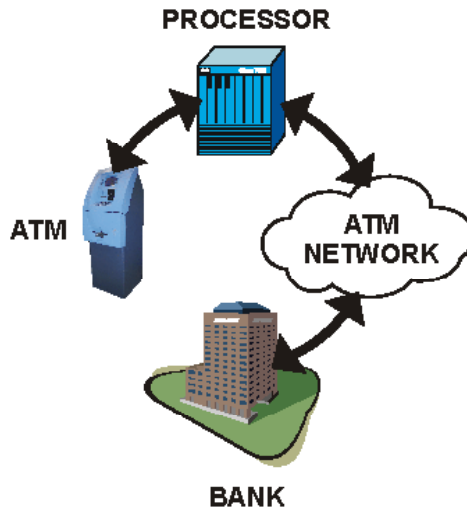

Figure 2-6. ATM transaction processing.

The ATM sends the customer transaction request to a processor. A processor is a financial intermediary, such as an Independent Sales Organization (ISO), bank, or other financial institution that provides transaction-processing services for ATMs. The ATM must be set up with a particular processor before customer transactions can take place.

The processor routes the transaction to the appropriate ATM network. An ATM network is a regionally or nationally organized clearing house for financial transactions, that deals directly with the appropriate financial institution, such as the customer's bank or credit card company, in order to complete the transaction. The processor will select the appropriate ATM network to use based on factors such as the type of ATM or credit card used, location of the customer's bank, or other considerations. The transaction may be transferred between several networks before ultimately reaching the customer's bank or credit card company.

The ATM network routes the transaction to the appropriate bank or other institution, confirms successful completion of the transaction, and sends a confirmation message back to the processor. If the request was for a cash withdrawal, an Electronic Funds Transfer (EFT) takes place to debit the funds (including any surcharge fee, if applicable) from the customer's bank account and credit the funds to the processor's bank account.

The processor forwards a confirmation message to the ATM (and an authorization to dispense currency, in the case of a cash withdrawal). The ATM dispenses the requested currency, if necessary, and provides the customer with a printed receipt as a record of the transaction.

The processor credits the merchant's account for the amount of any cash withdrawals (plus surcharge fees, if collected), typically by the end of the next business day).

VOICE-ENABLED TRANSACTION

The terminal provides voice feedback via an integrated output jack, enabling sight-impaired users to plug in a set of headphones and receive spoken instructions to assist them in using the ATM (Figure 2-7).

A raised symbol helps a user locate the headphone jack. The ATM will automatically detect when a headphone has been plugged into the jack, and will immediately switch into voice mode. Initially, a brief spoken tutorial will orientate the customer to the ATM control panel interface. Once the customer begins a transaction, spoken prompts will provide feedback and guide the customer through the successful accomplishment of the transaction.



*Figure 2-7. Headphone jack location.
(Typical)*



SDD

SECTION 3

CASSETTE CLOSE

CASH REPLENISHMENT

SCDU

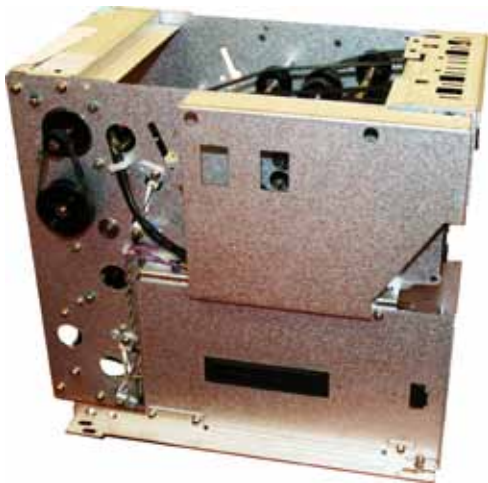

HCDU



INTRODUCTION

The purpose of this section of the manual is to describe the procedures for cassette closing and replenishment. Information concerning note handling and quality issues are explained where appropriate.

DISPENSING MECHANISMS

*** PLEASE READ ***

The Model RL331X production units are equipped with the SCU, SDD or HCDU dispenser.

Also, there will only be one style of cabinet offered which can accommodate the dispensers mentioned above.

Currency capacity depends upon the dispenser mechanism installed in the ATM, but is also affected by note quality and thickness. Typical capacities are provided in the following table: **DO NOT** be tempted to over fill the cassette.

RL331X DISPENSING MECHANISM

DISPENSER	CASSETTE	RECOMMENDED MAXIMUM CAPACITY	REJECTED NOTE CAPACITY
SCDU	Single	1000 Notes	Less than 100
SDD	Single	1800 Notes	Less than 100
HCDU	Duel	3500 Notes (1750 each)	Less than 100

The dispensing mechanism delivers the appropriate number of notes from the note cassette to fulfill the customer's withdrawal request. The purpose of the reject area or cassette is to accept and hold notes that have been transferred from the note cassette but not dispensed. Some situations that could cause the mechanism to reject notes are:

- (1) Multiple notes stuck together
- (2) Note width too short or long.

Other conditions that could cause a reject are described in the next section, Note Condition.

****CAUTION****

DO NOT RECYCLE REJECTED NOTES INTO A CASSETTE!
Doing so could cause more rejects and/or currency jams.

NOTE CONDITION

The number of rejects can be directly influenced by the technique used to load the cassettes and the quality of the currency. Notes loaded into the mechanism cassettes must be in “fit” condition if a high level of performance (low reject and failure rate) is expected from the unit. “Fit” notes are defined as those that do not possess any of the defects listed here:

USED NOTE DEFECTS

- Adhesive or “sticky” substances on the surface of the paper.
- Tears extending more than 1/2” from the edge of the currency.
- Tears, holes, or missing sections in the body of the currency.
- Tape on the surface of the currency used for repairing, patching or any other purpose.
- Staples, pins, or any other foreign body attached to the notes.
- Corner folds of a size greater than 1/2” on either axis.
- Two or more notes joined by any means.
- Excessively crumpled or crinkled notes.

PREPARING NOTES

Use the following procedures to prepare notes before inserting them into a note cassette.

PREPARING USED NOTES

- Remove the band around each bundle of notes.
- Remove foreign objects (e.g. pins, paper clips, crumbs, etc.).
- Remove torn or very worn notes.
- Straighten any folded notes.

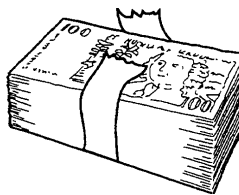

Figure 3-1. Removing band.

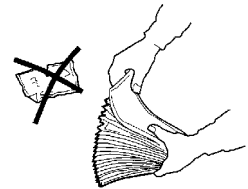

Figure 3-2. Removing torn/worn notes.

NEW OR UNCIRCULATED NOTES

Remove the band around each bundle of notes. Separate the notes from each other by:

- **Striking** the bundle hard against the edge of a table or similar object.
- **Flipping** through each bundle of notes in both directions at each end.
- Using a **note counter**. (highly recommended)

CASSETTE CLOSE PROCEDURES

Follow Access instructions to enter **MANAGEMENT FUNCTIONS**. Select **TERMINAL CLOSE FUNCTIONS**. Select **CASSETTE CLOSE**.

- ❶ Select cassette to Close. A check mark (✓) identifies which cassette is selected. “A”: is selected by default. Press <Enter>.
- ❷ After cassette has been reinserted in the dispenser, press <Enter>.

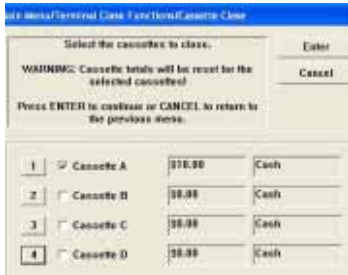

- ❸ A Close report is displayed to be printed or saved. This operation will reset the number of bills in the cassette to ZERO (0). Press <Enter>.



- ❹ Remove and Replenish the selected cassette.

Procedures for cassette replenishment are on the following pages.

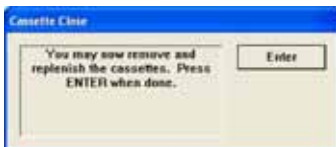

- ❺ Place selected cassette **IN SERVICE**. “A” will be in service. Press <Enter>.



- ❻ Enter Cassette Quantity (total number of notes, NOT value) for the selected cassette. Press <Enter> to accept entry.

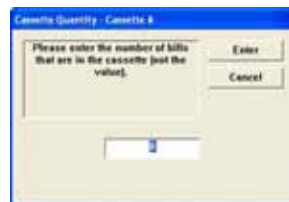

- ❼ A Trial Cassette Close report automatically is displayed to be printed or saved. Print and retain a copy for starting point reference. Press <Enter> to return to Close functions.

Replenish Cassette
SCDU/HCDU

1. Unlock and open the security cabinet door.
2. Remove any rejected notes. The reject compartment is located above the cassette.
3. To remove the note tray, grasp the tray handle, lift slightly, and slide the tray out of the mechanism. Place the note tray on a flat level surface. Use the security key to unlock the cassette, and open the lid.



Removing rejected notes.



Removing note tray from the dispensing mechanism.

Note: You may wish to record the number of notes removed from the reject compartment for use when balancing the note tray against the cassette/day close records.

Loading the Note Tray

1. Pull the packer plate to the rear of the tray (toward the handle). Ensure the packer plate is fully back. Maintain pressure on the packer plate as needed while loading notes.
2. Count the number of bills that remain in the cassette, if any. Next, count the number of bills that are being added into the cassette.
3. Add the number of bills being placed into the cassette to the number that remained. The “Total” number of these bills will be entered in the “Enter Cassette Quantity” option. (step 6 page 3-4)



Load note tray with currency.

4. Place the currency into the cassette. Allow at least one inch of clearance between the packer plate when it is fully retracted and the currency. This will allow the packer plate to compress the currency. Do not try to over fill.
5. Release the packer plate against the notes.
6. Close the lid and lock with the security key.
7. Using the handle, slide the note tray into the dispensing mechanism. Make sure the note tray is fully inserted!
8. HCDU- repeat steps 1-7 for additional cassette.
9. Ensure the Reject door is closed. Close and lock the security container.

Replenish Cassette
SDD

1. Unlock/Open the dispenser security door. Grasp the cassette handle and remove the cassette.



2. Cassette **MUST BE PRIMED** with the cassette key before inserting on the loading tray. Insert key and turn clockwise to show **GREEN** indicator in window.



Green window

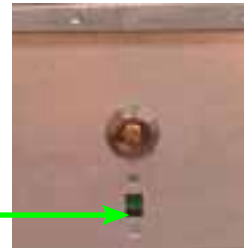

Cassette Primed

*****WARNING*****

IF RED IS INDICATED IN THE WINDOW ON THE SIDE OF THE CURRENCY CASSETTE, NEVER ATTEMPT TO INSERT THE CASSETTE INTO THE DISPENSER OR THE LOADING TRAY!

3. Slide cassette onto the loading tray. Lift lid to expose the reject tray. Remove any rejected notes.

DO NOT recycle rejected notes!

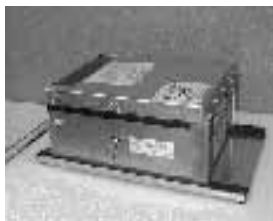

Cassette on
L o a d i n g
T r a y

Lid open to
expose Reject
Bin



4. Lift the reject tray. Push the packer plate to rear of cassette and latch in place.



5. Count the number of bills that remain in the cassette, if any. Count the number of bills that are being added to the remaining notes. The TOTAL of these amounts will be entered in the “Enter Cassette Quantity” prompt for Cassette Close procedure. (step 6 page 3-4)

6. Place currency in the cassette and slowly release the hold-back latch allowing the packer plate to move forward against the notes. Close the cassette lid.



7. Remove cassette from loading tray. Insert the cassette key and “PRIME” the cassette (“Green” indicator). Install the cassette into the dispenser.



8. Close and lock the security container.

SECTION 4

GENERAL MAINTENANCE



INTRODUCTION

This section of the manual covers preventive and corrective maintenance procedures appropriate for user personnel. The following areas are covered:

1. **REPLENISHING RECEIPT PAPER.** Describes how to replace a spent receipt paper roll.
2. **CLEANING THE ENCLOSURE.** The proper way to clean the ATM housing.
3. **CARD READER CLEANING.** The recommended card reader cleaning technique.

Important

Only qualified service personnel are authorized to repair or service the terminal. Should a malfunction occur, DO NOT attempt to service the unit yourself! Contact your Triton certified service provider!

REPLENISHING THE RECEIPT PAPER

NOTE: This operation must be completed with the AC power applied to the ATM.

1. Open the control panel by unlocking the top enclosure and pulling the door and tray forward.
2. If paper remains on the roll, move the Green lever down to release the print head. Carefully pull the excess paper back through the printer.

**** Caution ****

DO NOT pull receipt paper backwards through the printer with the GREEN lever in the UP position! This may leave paper fragments that can cause paper jams.

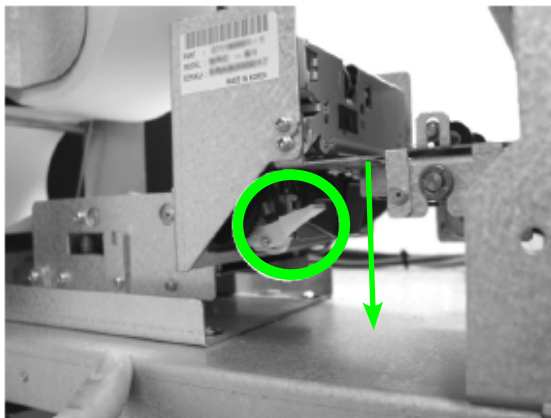

GENERAL MAINTENANCE

- Return the Green lever back to the Up position, ensure it clicks securely. You may push up on the print roller to aid in this operation.

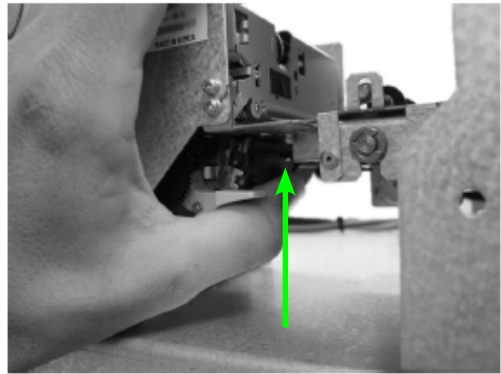

- Remove the paper and spool from the paper bracket.
- Remove the tab securing the end of the new paper roll to itself. Use scissors to cut off all of the paper up to and including the glue tab, producing a clean square cut.
- Remove the plastic spindle from the old paper roll and insert into the new roll of paper. Use a 5 inch roll of 58 mm wide thermal paper, printer applicable, with a small center. Replacement paper is available from Triton.
- Be sure the spindle is inserted so that the paper will feed from the ***BOTTOM*** of the roll when it is installed on the paper bracket and facing the rear, where it will curl back under the tension bar.

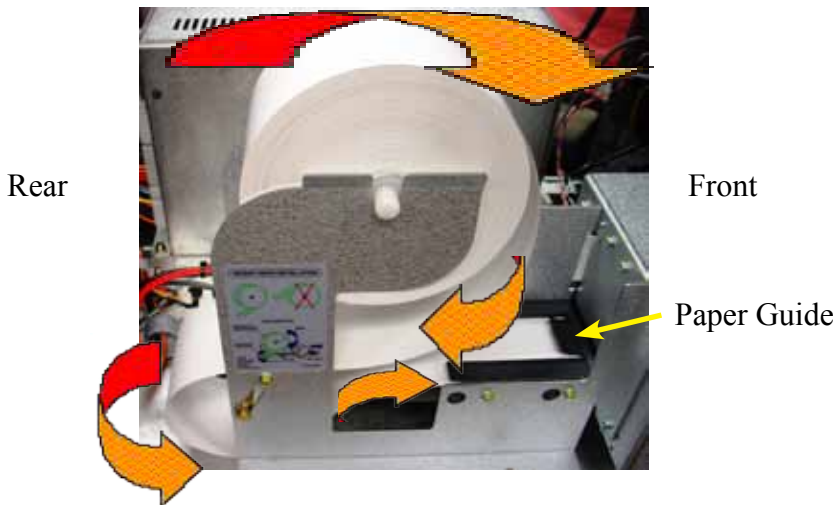

- Place the new roll back on the paper bracket by sliding the small, slotted end of the spindle onto the slot in the bracket as shown. **Note that the paper feeds from the BOTTOM of the roll, toward the rear!**

MODEL RL331X USER MANUAL

9. Feed the end of the paper over the stationary bar, around and under the tension bar, and into the Printer Paper Guide. (Illustration from step 7) Push the paper forward into the printer. The printer will activate and automatically feed the paper through the printer and present approximately 4 inches of paper out the front.

NOTE: A new full roll of paper will be heavy enough to produce a loop, as shown at the right. This is normal. As the roll depletes, the loop will get smaller and eventually contact the Tension Bar. (This view from the opposite side for clarity)

A diagram is posted on the left side of the printer.

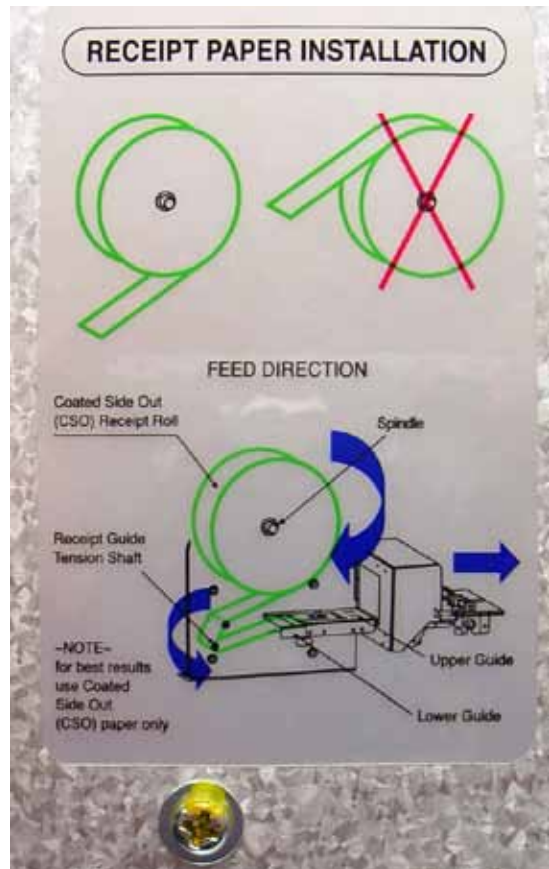
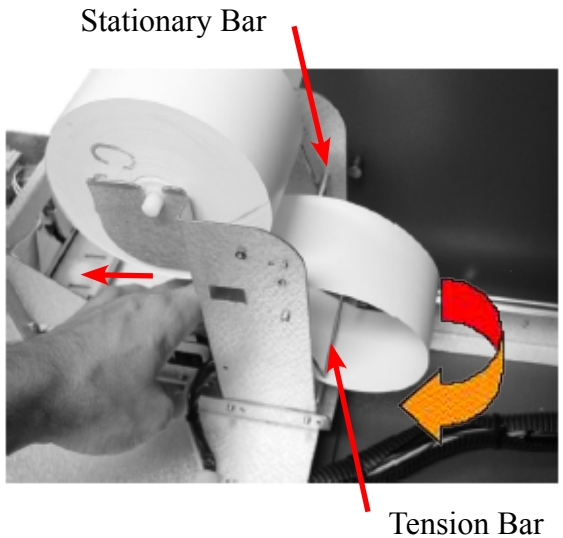

CLEANING THE ENCLOSURE

The ATM front panel is highly durable, resisting scratches and finger smudges. However, occasional cleaning of the front panel and the plastic enclosure may be desirable. A soft dry or slightly damp cloth may be used for cleaning. For best results, use a weak solution of a mild detergent and water.

**** Caution ****

**Avoid using abrasive cleaners on any surface of the terminal.
Do not spray liquid cleaner directly on the unit, inside or out.**

CLEANING THE DISPLAY

The Liquid Crystal Display (LCD) on the front of the ATM has a plastic protective window that should be cleaned only with a soft cloth, dampened with a weak solution of a mild detergent and water.

**** Caution ****

Do not use any abrasive cleaners on the window as it will scratch. Do not spray liquids onto the screen as they may run down inside the unit and cause damage.

CARD READER CLEANING

Special cleaning cards (mag head P/N 06200-00055, EMV P/N 05010-00024) are available for proper maintenance of the card reader. The reader should be cleaned at least once a month by inserting and removing a cleaning card, as shown below. It may be necessary to clean the card reader more often in locations that see heavy usage.

1. Remove the cleaning card from the sealed pouch.
2. Insert the cleaning card into the card reader and move in and out several times.
3. Remove the cleaning card and turn over to use other side.
4. Insert again several times.
5. Remove cleaning card and discard. They are designed to be used only once.

THIS PAGE INTENTIONALLY LEFT BLANK

APPENDIX A
SOFTWARE LICENSE AGREEMENT
COMPLIANCE / EMISSION STATEMENTS

**AUTOMATED TELLER MACHINE (“ATM”) SOFTWARE
END-USER AGREEMENT**

IMPORTANT: PLEASE READ CAREFULLY:

BY INSTALLING OR OTHERWISE USING THE ATM, YOU (AS THE OWNER OR LESSEE OF THE ATM). AGREE TO BE BOUND BY THE FOLLOWING TERMS AND CONDITIONS, INCLUDING, WITHOUT LIMITATION, THE WARRANTY DISCLAIMERS, LIMITATIONS OF LIABILITY AND TERMINATION PROVISION WHICH APPLY TO YOUR USE OF THE ATM SOFTWARE CONTAINED IN THIS ATM AND IS HEREBY LICENSED BY TRITON SYSTEMS OF DELAWARE, LLC. (“Triton”) TO YOU PURSUANT TO THIS AGREEMENT.

IF YOU DO NOT AGREE TO OR ARE NOT WILLING TO BE BOUND BY THE TERMS AND CONDITIONS OF THIS AGREEMENT, DO NOT INSTALL OR OTHERWISE USE THIS ATM AND PROMPTLY CONTACT YOUR VENDOR. INSTALLING OR OTHERWISE USING THE ATM INDICATES THAT YOU ACCEPT THESE TERMS.

This ATM is manufactured by, and utilizes proprietary software owned by Triton Systems of Delaware, LLC. and/or its suppliers. All right, title and interest in and to all component software installed or embedded in the ATM (“ATM Software”) including all associated intellectual property rights, are and will remain the property of Triton and/or its suppliers.

LICENSE: Triton grants you a limited, nonexclusive license to use the ATM Software but only in connection with the operation of this ATM subject to the terms and restrictions set forth in this License Agreement. You are not permitted to use the ATM Software in any manner not expressly authorized by this License. You acknowledge and agree that ownership of the ATM Software and all subsequent copies thereof regardless of the form or media are held by Triton or its suppliers.

The software is licensed for use on this specific Triton ATM product and may not be used on any other product. Otherwise, the supporting documentation, if any, may be copied only as essential for backup or archive purposes in support of your use of the ATM. You must reproduce and include all copyright notices and any other proprietary rights notices appearing on any copies that you make.

ASSIGNMENT: NO REVERSE ENGINEERING: You may transfer the ATM Software to another party but only in connection with a transfer of all your right, title and interest in and to this ATM and if such party accepts the terms and conditions of this License Agreement. If you transfer the ATM, you must at the same time transfer the supporting documentation, if any, to the same party or destroy any such materials not transferred. Modification, reverse engineering, reverse compiling, or disassembly of the ATM and/or the ATM Software is expressly prohibited.

DISCLAIMER OF WARRANTIES AND LIMITATION OF DAMAGES

TO THE EXTENT PERMITTED BY LAW, THIS ATM SOFTWARE, INCLUDING ALL INCORPORATED THIRD PARTY SOFTWARE, AND DERIVATIVES IS PROVIDED, "AS IS". TRITON MAKES NO REPRESENTATIONS WITH RESPECT TO, AND DOES NOT WARRANT THE PERFORMANCE OR RESULTS YOU OR YOUR CUSTOMERS MAY OBTAIN BY USING THE ATM. TRITON SPECIFICALLY DISCLAIMS ANY AND ALL WARRANTIES, EXPRESS, IMPLIED OR STATUTORY, INCLUDING WITHOUT LIMITATION, WARRANTIES OF QUALITY, PERFORMANCE, NONINFRINGEMENT, AND MERCHANTABILITY OR FITNESS FOR ANY PARTICULAR PURPOSE.

TRITON MAKES NO REPRESENTATIONS OR WARRANTIES AND ASSUMES NO OBLIGATIONS TO YOU OR YOUR CUSTOMERS WITH RESPECT TO ANY TRANSACTION OR SERVICES ACCESSED AND/OR UTILIZED IN CONSUMER-INITIATED TRANSACTIONS MADE FROM THIS ATM. IN NO EVENT WILL TRITON, ITS AFFILIATES, DIRECTORS, OFFICERS, EMPLOYEES, AGENTS OR SUPPLIERS BE LIABLE TO YOU UNDER ANY THEORY OF TORT, CONTRACT, STRICT LIABILITY OR OTHER LEGAL OR EQUITABLE THEORY FOR ANY PUNITIVE, CONSEQUENTIAL, INCIDENTAL, SPECIAL OR SIMILAR DAMAGES, INCLUDING ANY LOSS PROFITS OR LOST SAVINGS, EVEN IF A TRITON AGENT OR REPRESENTATIVE HAS BEEN ADVISED OF THE POSSIBILITY OF SUCH DAMAGES, OR FOR ANY CLAIM BY ANY THIRD PARTY.

YOUR SOLE REMEDY AGAINST TRITON FOR DEFECTIVE PERFORMANCE OF THE ATM SOFTWARE WILL BE LIMITED EXCLUSIVELY TO REPAIR OR REPLACEMENT OF THE ATM AND/OR THE ATM SOFTWARE, AT TRITON'S SOLE DISCRETION.

Any warranty pertaining to the ATM, its mechanical components exclusive of the ATM software, shall be governed and controlled by any warranty given to you by Triton in a separate document accompanying this ATM.

The foregoing limitation of liability and exclusion of certain damages will apply regardless of the success or effectiveness of other remedies.

GOVERNING LAW: This License Agreement shall be governed by the laws of the State of Mississippi and by the laws of the United States, excluding their conflicts of laws principles.

SEVERABILITY: In the event any provision of this License Agreement is found to be invalid, illegal or unenforceable, the validity, legality and enforceability of any of the remaining provisions shall not in any way be affected or impaired.

ENTIRE AGREEMENT: This License Agreement and the accompanying Limited Warranty set forth the entire agreement between you and Triton, supersedes all prior agreements, whether written or oral, with respect to the ATM Software, and may be amended only in writing signed by both parties.

COMPLIANCE / EMISSION STATEMENTS

DISCLAIMER

The manufacturer of the Automated Teller Machine (ATM) product(s) described herein makes no representations or warranties, either expressed or implied, by or with respect to anything in this manual, and shall not be liable for any implied warranties of fitness for a particular purpose or for any indirect, special, or consequential damages. Information in this document is subject to change without notice and does not represent a commitment on the part of the manufacturer.

**** CAUTION ****

Changes or modifications not expressly approved by Triton Systems could void the regulatory compliance approval and the warranty. Use of this product in a manner other than those described in this manual may result in personal injury!

EMISSIONS (EMI)

(US Requirements)

This device complies with Part 15 of the FCC rules. Operation is subject to the following two (2) conditions:

- 1) This device may not cause harmful interference.
- 2) This device must accept any interference received, including interference that may cause undesired operation.

NOTE:

This equipment has been tested and found to comply with the limits for a Class A digital device pursuant to Part 15 of FCC rules. These limits are designed to provide reasonable protection against harmful interference when the equipment is operated in a commercial environment. This equipment generates, uses, and can radiate radio frequency energy and, if not installed and used in accordance with the instruction manual, may cause harmful interference to radio communications. Operation of this equipment in a residential area is likely to cause harmful interference in which case the user will be required to correct the interference at his own expense. Changes or modifications to this unit not expressly approved by the party responsible for compliance could void the user's authority to operate the equipment.

CANADIAN REQUIREMENTS

This digital apparatus does not exceed the Class A limits for radio noise emissions from digital apparatus set in the Radio Interference Regulations of the Canadian Department of Communications. This Class A digital apparatus complies with Canadian ICES-003.

Le present appareil numerique n'emet pas de bruits radioelectriques dépassant les limites applicables aux appareils numeriques de la Class A prescrites dans le Reglement sur le brouillage radioelectrique edicte par le ministre des Communications du Canada. Cet appareil numerique de la classe A est conforme a la norme NMB-003 Canada.

UK / AUSTRALIA / SOUTH AFRICA REQUIREMENTS

Warning:

This is a Class A product. In a domestic environment, this product may cause radio interference in which case the user may be required to take adequate measures.

APPENDIX B

WARRANTY SERVICE STATEMENT

Manufacturer warrants that the Products delivered to Distributor will perform in accordance with the Manufacturer's published specifications, and as outlined in the Manufacturer's booklet entitled "Thirteen Months Parts Only Limited Warranty" for thirteen months from date of shipment in Long Beach, MS. Distributor acknowledges that it has received a copy of such booklet, that it has read its entirety and that it understands and agrees with its contents.

Manufacturer's warranty shall not apply to any damage resulting from abuse, negligence, accident, or to any loss or damage to the products while in transit.

Written notice and explanation of circumstances surrounding any claims that the goods have proved defective in material or workmanship shall be given promptly from the distributor to the manufacturer. No claim may be made, or action brought, by or through a distributor after the expiration of 14 months following any alleged breach of warranty.

DISTRIBUTOR'S SOLE AND EXCLUSIVE REMEDY IN THE EVENT OF DEFECT IS EXPRESSLY LIMITED TO THE REPLACEMENT OR CORRECTION OF SUCH DEFECTIVE PARTS BY MANUFACTURER AT ITS ELECTION AND SOLE EXPENSE, EXCEPT THERE SHALL BE NO OBLIGATION TO REPLACE OR REPAIR ITEMS WHICH, BY THEIR NATURE, ARE EXPENDABLE. If

Manufacturer is unable to replace or repair the defective parts, Manufacturer shall refund to Distributor that portion of the purchase price allocable pays to such goods.

No representation or other affirmation of fact not set forth herein, including but not limited to statements regarding capacity, suitability for use, or performance of the goods, shall be or be deemed to be a warranty or representation by Manufacturer for any purpose, nor give rise to any liability or obligation of Manufacturer whatever.

EXCEPT AS SPECIFICALLY PROVIDED IN THIS DOCUMENT, THERE ARE NO OTHER WARRANTIES EXPRESSED OR IMPLIED INCLUDING, BUT NOT LIMITED TO, ANY IMPLIED WARRANTIES OR MERCHANTABILITY OR FITNESS FOR A PARTICULAR PURCHASE.

LIMITATION OF LIABILITY

IN NO EVENT SHALL MANUFACTURER BE LIABLE FOR LOSS OF PROFITS OR INCIDENTAL, INDIRECT, SPECIAL, CONSEQUENTIAL OR OTHER SIMILAR DAMAGES ARISING OUT OF ANY BREACH OF THIS CONTRACT OR OBLIGATIONS UNDER THIS CONTRACT.

DEFENSE OF INFRINGEMENT CLAIMS

If notified promptly in writing of any action (and all prior claims relating to such action) brought against the Distributor based on a claim that Distributor's use of the goods infringes a patent or other intellectual property right, and if given access by Distributor to any information distributor has regarding such alleged infringement, Manufacturer agrees to defend Distributor in such action at its expense and will pay any costs or damages finally awarded against Distributor in any such action, provided the Manufacturer shall have had sole control of the defense of any such action and all negotiations for its settlement or compromise.

In the event that a final injunction shall be obtained against the Distributor's use of the goods or any of their parts by reason of infringement of a patent or other intellectual property right or if in Manufacturer's opinion the goods are likely to become the subject of a claim of infringement of a patent or other intellectual property right, Manufacturer will, at its option and at its expense, either procure for the Distributor the right to continue using the goods, replace or modify the same so they become non-infringing or grant the Distributor a credit for such goods as depreciated and accept their return. The depreciation shall be an equal amount per year over the lifetime of the goods as established by Manufacturer.

Manufacturer shall not have any liability to the Distributor under any provision of this clause if any infringement, or claim thereof, is based upon: (i) the use of the goods in combination with other goods or devices which are not made by Manufacturer; (ii) the use of the goods in practicing any process; (iii) the furnishing to the Distributor of any information, data, service, or applications assistance; or (iv) the use of the goods with modifications made by the Distributor. The Distributor shall hold Manufacturer harmless against any expense, judgment or loss for infringement of any patent or other intellectual property right which results from Manufacturer's compliance with the Distributor's designs, specifications or instructions. No costs or expenses shall be incurred for the account of Manufacturer without the written consent of Manufacturer. THE FOREGOING STATES THE ENTIRE LIABILITY OF MANUFACTURER WITH RESPECT TO INFRINGEMENT OF PATENTS OR OTHER INTELLECTUAL PROPERTY RIGHT BY THE GOODS OR ANY PART THEREOF, OR BY THEIR OPERATION.

INTERPRETATION AND OTHER PAROLE EVIDENCE

This writing is intended by the parties as final expression of their agreement and is intended also as a complete and exclusive statement of the terms of their agreement. No course of prior dealing between the parties and no usage of the trade shall be relevant to supplement or explain any term used in these terms and conditions. Acceptance or acquiescence in a course of performance rendered under these terms and conditions shall not be relevant to determine the meaning of these terms and conditions even though the accepting or acquiescing party has knowledge of the performance and opportunity for objection. Whenever a term defined by the Uniform Commercial Code, as adopted in Mississippi, is used in these terms and conditions, the definition contained in the code is to control.

MODIFICATIONS

These terms and conditions can be modified or rescinded only by writing signed by both the parties or their duly authorized agents.

WAIVER INEFFECTIVE

No claim or right arising out of or relating to a breach of these terms and conditions can be discharged in whole or in part by a waiver or renunciation of the claim or right unless the waiver or renunciation is supported by consideration and is in writing signed by the aggrieved party. Waiver by either Manufacturer or Distributor of a breach by the other of any provision of these terms and conditions shall not be deemed a waiver of future compliance there with, and such provisions shall remain in full force and effect.

STATUTE OF LIMITATIONS

Any action by the Distributor or Manufacturer for breach of these terms and conditions must be commenced within one (1) year after the cause of action has accrued.

APPLICABLE LAW

These terms and conditions shall be governed by and construed in accordance with the provisions of the Uniform Commercial Code as adopted by the State of Mississippi.

BANKRUPTCY

In the event of any proceedings, voluntary or involuntary, in bankruptcy or insolvency by or against Distributor, or in the event of the appointment, with or without the Distributor's consent, of an assignee for the benefit of creditors or of a receiver or of a liquidator, then Manufacturer shall be entitled to cancel any unfilled part of these terms and conditions without any liability whatsoever.

PARTS ONLY LIMITED MANUFACTURER'S WARRANTY

Triton Systems of Delaware, LLC. warrants the components of each ATM, excluding software and related documentation, against any defect in materials and/or workmanship for a period of 13 months from the shipping date. If a component fails due to defects in materials and/or workmanship within the warranty period, Triton will furnish a new or refurbished component, at its discretion. Triton shall not be responsible for labor or other costs associated with installing the components and the failed component shall be returned to Triton at the purchaser's expense. Triton shall not be responsible for misuse or abuse of a unit and any attempts to remove or deface the serial number or date code on a unit or any component thereof, or any attempt to repair a unit or to repair or replace any component by anyone other than a service technician authorized by Triton shall void this warranty.

CALLS FOR SERVICE OR REPAIR

Calls for service or repair will be accepted from authorized service technicians only. End users must contact either the sales organization that placed the equipment or an authorized third party service organization to obtain service. The sections that follow describe the policies and procedures that relate to the repair and replacement of malfunctioning equipment.

QUESTIONS ON OPERATION OF EQUIPMENT

Technical support is available to owners of Triton equipment and to qualified service personnel. When calling for help with the configuration or operation of a Triton product, the caller must provide either positive identification as a service technician or the serial number of a Triton terminal. Technical support is provided during normal business hours for the life of the product.

When calling for help with an operational problem, please have available information pertaining to the nature of the trouble. This includes the type of equipment, examples of what is or is not happening, and the name of the processor that supports your terminal.

All questions pertaining to the settlement of accounts, transaction inquiries, and fund status must be directed to the processor. Triton does not have access to the information needed to answer questions relating to specific transactions.

CONTACT INFORMATION

Triton Systems of Delaware, LLC.
21405 B Street
Long Beach, MS 39560

SALES:

1 (800) 259-6672
1 (228) 575-3100
(Fax) 1 (228) 868-9445

SERVICE:

1 (800) 259-6672 (Technical Support)
1 (228) 575-3101 Fax (Technical Support)

APPENDIX C

ELECTRONIC LOCKS AND BATTERY

STRAIGHT DEAD BOLT



SWING BOLT

**** IMPORTANT ****

Read this page BEFORE proceeding. New imperative information.

Super Master Reset Password

BOTH types of electronic locks are now set with a Super Master Reset Password. The Super Master Reset Password should only be used if the Manager Password has been lost/forgotten. Using the Super Master Reset Password will reset the lock back to factory state however once the Super Master Reset Password has been changed from the factory default code, it CANNOT and WILL NOT change unless a hard reset of the lock is performed.

*Upon arrival, the Super Master Reset Password combination of the lock is set at **5-5-5-5-5-5-5-5**.
That is EIGHT number 5s.

Change this password **IMMEDIATELY**, before the Manager Default Code, or this function will be permanently lost.

To Change the Super Master Reset Password (SMR):

1. Press and hold the ZERO (0) for three (3) seconds.
2. The lock will beep twice and the LED light will come ON (and stay ON until the process is complete).
3. Enter the default code of 5-5-5-5-5-5-5-5 holding the last digit for three (3) seconds.
4. The lock is now in Command Menu mode. SMR has two (2) Command Options:
 - Press zero (0) to Change Code (one-time use ONLY).
 - Press eight (8) to Reset the Manager Password (reset the lock).
5. TO BE CONTINUED - - - - - More info from La Gard needed

Entering the Combination - Both Styles

The electronic lock combination(s) consists of six digits. Upon arrival, the combination(s) of the lock should already be set at **1-2-3-4-5-6**.

After installation of the unit has been completed:

1. Enter the preset combination and check for proper operation. After each keypress, the lock will beep. After the final digit has been entered, the lock will beep twice and the open period will begin.
 2. Within **four (4)** seconds, turn the Straight Deadbolt keypad clockwise to the open position.
 3. The Swing Bolt style will retract when the door is opened. **See note: page C6**
 4. After the lock is opened, the door may be opened.
- Invalid Code Entry** - Lock will beep three (3) times. Repeat Steps 1 - 3.

Changing the Combination - Both Styles

**** IMPORTANT ****

Always perform this operation with the door open.

If your unit is programmed for Dual Code (see **Programmable Features**), each code must be changed independently. Follow these instructions for each code change.

To change the combination of the lock:

1. Enter **six (6) zeros**.
 2. Enter the **current** combination (initially set at **1-2-3-4-5-6**).
 3. Enter the **new** six (6) digit combination **twice**.
 - If a mistake is made, wait thirty (30) seconds and repeat steps 1 -3.
 4. Test lock combination several times before closing the door. The combination is now changed.
- Valid Code Entry** - Double signal after valid six (6) digit code is entered.
Invalid Code Entry - Triple signal and old code is still valid.

Lockout Feature

The lock includes a **WRONG TRY PENALTY** lockout feature that prevents entry from unauthorized personnel. This feature performs as follows:

- Entry of four (4) consecutive invalid combinations starts a 5-minute delay period.
 - LED flashes RED at ten (10) second intervals.
- At the end of the delay period, two (2) more consecutive invalid combinations will restart an additional 5-minute delay. **Entry will not respond to a single keystroke during delay period.**

Programmable Features

The locks are initially set with the standard feature of a single 6-digit code.
Based on your requirements, additional features may be added in the lock **BUT THEY MUST BE PRE-PROGRAMMED by Triton** prior to shipment of the unit.

- Manager (Factory set to 1-2-3-4-5-6):

Add/remove second user
Enable/disable second user

- Dual Code:

Two (2) combinations required to open.

- Silent Signal Alarm (Optional alarm box required):

Duress signal if last number of code(s) is entered using one (1) number higher or one (1) number lower.

Time Delay:

Delay period 1-99 minutes.

Open period 1-19 minutes

- Time Delay Override:

Ability to add second combination to override delay period

- Disable Lock (Optional alarm box required):

Input signal disables opening of lock by valid code

Programmable Feature(s) descriptions:

Add User (If Manager, Time Delay Override, Remote Override, or Dual Combination feature programmed)

Always perform this operation with the door open

1. Enter Manager Code and HOLD DOWN LAST DIGIT OF CODE until the lock signals with two (2) sets of double beeps.
 2. PRESS 1. Lock signals twice. Lock will only signal twice if the User code is not already in use. It will beep once if a User is already installed and three (3) times if the function has not been programmed in the lock.
 3. Enter User code twice. The lock signals twice after each valid entry.
 4. If a mistake is made, wait thirty (30) seconds and repeat steps 1 - 3.
- Valid Code Entry** - Double signal after valid six (6) digit code is entered.
Invalid Code Entry - Triple signal and old code is still valid.

Disable User (Manager feature only)

Always perform this operation with the door open

1. Enter Manager Code and HOLD DOWN LAST DIGIT OF CODE until the lock signals with two (2) sets of double beeps.
2. PRESS 2. Lock signals once. User is now temporarily disabled.
3. If a mistake is made, wait thirty (30) seconds and repeat steps 1- 2.

Reinstate User (Manager feature only)**Always perform this operation with the door open**

1. Enter Manager Code and HOLD DOWN LAST DIGIT OF CODE until the lock signals with two (2) sets of double beeps.
2. PRESS 1. Lock signals once. User is now reinstated.
3. If a mistake is made, wait thirty (30) seconds and repeat steps 1 - 2.

Remove User (Manager feature only)**Always perform this operation with the door open**

1. Enter Manager Code and HOLD DOWN LAST DIGIT OF CODE until the lock signals with two (2) sets of double beeps.
2. PRESS 3. Lock signals once. User is now permanently removed.
3. If a mistake is made, wait thirty (30) seconds and repeat steps 1 - 2.

Dual Code Operation (if feature is programmed)**Always perform this operation with the door open**

1. Must add second user to open lock (See **ADD USER**).
 - Second user **CANNOT** be Disabled or Removed.
2. After first code is entered, second code must be entered within ten (10) seconds.
3. Both codes required to open lock in Open period.

Silent Signal Alarm (if feature is programmed AND optional Alarm Box is connected to an alarm system)**Always perform this operation with the door open**

1. Enter last digit of code one (1) number higher or one (1) number lower.
 Example: Code: 1-2-3-4-5-6
 Duress: 1-2-3-4-5-5 or 1-2-3-4-5-7
2. The lock will open without any indication that the duress signal has been sent.

Time Delay (if feature is programmed)**Always perform this operation with the door open**

1. Enter valid code.
 - Time Delay period starts (1-99 minutes pre-programmed).
 - LED flashes RED at one (1) second intervals.
 - If valid code entered during delay, Time Delay period restarts.
 - If invalid code(s) entered during delay, Time Delay period aborts.
2. At end of Time Delay period, Open period starts (1-19 minutes pre-programmed).
 - LED flashes RED at 1/2 second intervals.
 - Lock beeps at ten (10) second intervals
3. During Open period, enter valid code(s).
 - If invalid code entered during open, Open period continues.
 - If four (4) consecutive invalid codes entered, **WRONG TRY PENALTY** starts.

Time Delay Override (if feature is programmed)**Always perform this operation with the door open**

1. Must add second code (See **ADD USER**).
 - Second user **CANNOT** be Disabled or Removed.
2. Entry of Time Delay Override code during Delay period will open lock.

Battery Maintenance

Battery Low Warning

Repeated beeping during an opening indicates that the battery is low and needs to be replaced. Triton recommends replacement of the battery at least twice annually. The battery box is located on the inside of the door.

Note: If the lock will not operate (i.e. repeated beeping or no beeping) while the door is closed and locked, the battery must be energized from the two external terminals on the front of the push-button panel.

To energize the lock, connect a 9-volt alkaline battery on the external terminal points. While maintaining contact, enter a valid combination and turn the dial clockwise to open the lock.

Note: You must maintain battery contact at all times throughout this procedure.

Changing the Battery - Straight Deadbolt

1. Open the ATM vault door(s). Remove the battery box cover by pulling the front portion away from the vault door.
2. The connector is easily removed by unsnapping it from the two (2) terminal on the top of the battery.
3. Remove the old battery. Install/connect a new 9-volt alkaline battery.
4. Push the battery and the leads completely up into the battery compartment.
5. Reinstall the cover and test the unit several times before closing the vault door.

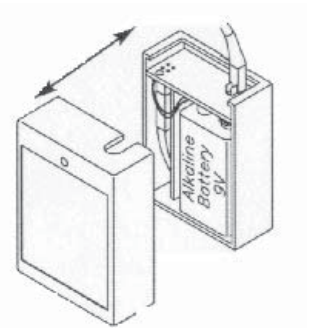

Changing the Battery - Swing Bolt Style

1. Grasp the dial firmly, and push up 1/4 inch to dislodge the dial
2. Remove from the Standoff Mounting Bolts
3. Replace the 9-volt battery
4. Install the dial by placing on the Standoff Mounting Bolts
5. Push in a downward direct to engage.

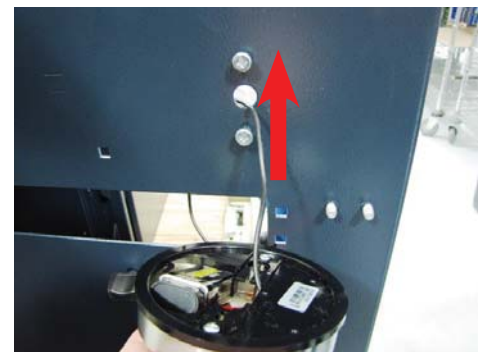

NOTE: Do **NOT** close the door without checking the operation of the combination and making certain it is programmed correctly. This style lock **WILL** auto lock if the door is closed/latched. If you DO NOT have the Super Master Reset Password programmed or have misplaced both the Master Password and the Super Master Reset Password, the lock will require drilling by a certified licensed locksmith.

APPENDIX D

MECHANICAL LOCKS

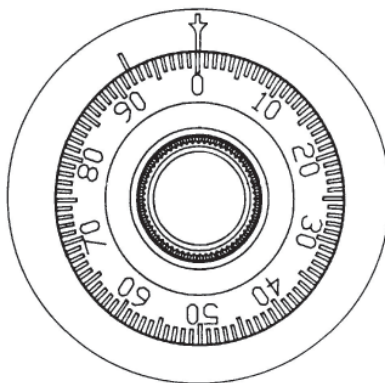

Entering the Combination

There are two marks on the dial ring (Refer to Figure 1). The index at the top is used for opening the lock.

The index 30 degrees to the left is used only when changing the combination.

The dial should always be turned slowly and evenly. A revolution is counted each time the selected number is aligned with the opening index. **DO NOT TURN THE DIAL BACK TO COMPENSATE FOR OVER DIALING A NUMBER.** If, when dialing the combination, any number is turned beyond the index, the entire sequence must be repeated. Locks are shipped on a single number **factory setting of '50'**. To unlock, turn the dial to the left (counterclockwise) **FOUR** turns stopping on '50'. Then, turn the dial to the right until the bolt is retracted. The Mas Hamilton lock is the only mechanical lock shipped with a factory combination of **"50-25-50"**.

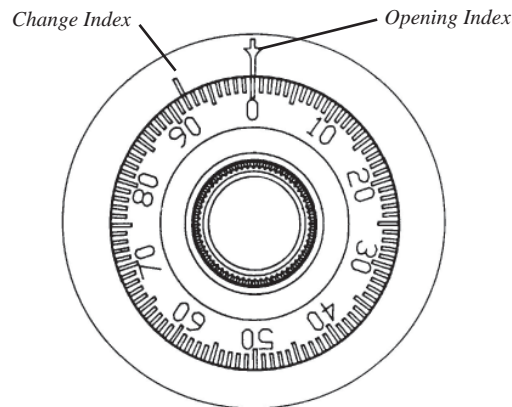

Figure 1. The changing and opening indices on the dial ring of the mechanical combination lock dial.

UNLOCKING A 3-NUMBER COMBINATIONS (EXAMPLE, "25-10-25")

1. Turn the dial to the **LEFT**, stopping when '25' is aligned with the opening index, the **FOURTH** time.
2. Turn the dial to the **RIGHT**, stopping when '10' is aligned with the opening index, the **THIRD** time.
3. Turn the dial to the **LEFT**, stopping when '25' is aligned with the opening index, the **SECOND** time.
4. Turn the dial slowly to the **RIGHT** until the bolt retracts.

LOCKING THE LOCK

Turn the dial to the **LEFT** at least four full revolutions.

CHANGING THE COMBINATION

Select three new numbers. **DO NOT** use any number between 1 and 20 for the last number.

For maximum security, do not use numbers that end in 0 or 5, and do not use numbers in sequence: e.g., '27-48-86' is not as good as '27-86-48". Perform the following steps:

1. Dial the existing combination on the opening index (see steps 1-2-3 previously, or the directions for opening when on the factory setting). Open door of container.
2. Refer to Figure 1. Dial the existing combination again, using the changing index.
3. With the last number set at the changing index, hold the dial securely and insert the change key in the keyhole in the back of the lock. Make sure the wing is entirely inside the lock and comes to a positive stop (see Figure 2) before turning the key.
4. Turn key one-quarter turn to the **LEFT** (see Figure 2). With the change key in this position, set the new combination as follows:
 - a. Turn the dial to the **LEFT**, stopping when the first number of the new combination aligns with the changing index the **FOURTH** time.
 - b. Turn the dial to the **RIGHT**, stopping when the second number is aligned with the changing index, the **THIRD** time.
 - c. Turn the dial to the **LEFT**, stopping when the third number is aligned with the changing index, the **SECOND** time. Holding the dial in this position, turn the change key back to the **RIGHT** and remove it (See Figure 3). The new combination you have chosen is now set in the lock.

TEST THE NEW COMBINATION BEFORE CLOSING THE DOOR

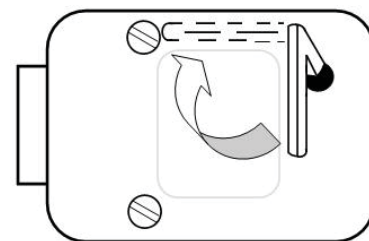

Figure 2. Turn the change key one-quarter turn clockwise to allow a new combination to be entered.

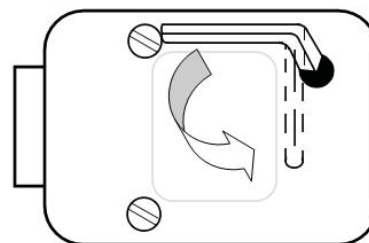

Figure 3. After entering the last number of the combination, turn the change key one-quarter turn counterclockwise and remove the key.

APPENDIX G

T9 KEYPAD



COPYRIGHT NOTICE

© 2014 Triton. All Rights Reserved. TRITON logo is a registered trademark of Triton Systems of Delaware, LLC

Document Updates

May 14, 2014 Original

**** WARNING ****

Once the T9 EPP Keypad is installed and activated in the unit, it **CANNOT** be removed.

If the keypad is removed from the unit after activation, reactivation is required and can only be performed by Triton Technical Support.

The T9 EPP Keypad is mostly identical to the T5 EPP Keypad except for:

- The T9 EPP contains a removal detection switch that deactivates / TAMPERS the EPP if the EPP is ever removed from the ATM.
- Left and right halves of 3DES keys must be different.
- No two 3DES keys may have the same value.
- When replacing current keypad with a T9 EPP, activation is required upon installation.

Contents

NEW ERROR CODES.....	3
TO INSTALL THE T9 KEYPAD.....	4
PRIOR TO T9 KEYPAD ACTIVATION.....	5
TO ACTIVATE THE T9 KEYPAD.....	6
TO RECTIVATE THE T9 KEYPAD.....	7
REPLACING THE BATTERY IN THE T9 KEYPAD.....	8

New Error Codes to Support the T9 EPP

- Error Code 625: SPED - Not Activated
Cause: The EPP has not yet been activated for use.
Recommended Action: Activate the EPP.
- Error Code 626: SPED - Not Authorized
Cause: The EPP has been removed from the ATM.
Recommended Action: Call Triton Technical Support for activation code.

To Install the T9 Keypad

The T9 EPP Keypad is a drop in replacement for new units manufactured with a T5 or T7 EPP Keypad. No additional parts are required.

- All RL1613, Traverse and ARGO were manufactured with a T5 or T7 EPP. (See NOTE below)
- All X2 RL23XX, RL53XX and RT23XX were manufactured with a T5 or T7 EPP beginning January 2, 2008 (Julian date of 08002).

If the ATM has been updated from VISA T1 EPP to T7 OR it needs to be updated from a VISA T1 EPP, the applicable kits are available.

- All XScale RL51XX, RT21XX and FT51XX were manufactured with VISA T1 EPP beginning December 29, 2004 (Julian date of 04363). Field Installation Instructions are available on www.TritonATM.com.

The software must be updated to 3.3.2 or newer.

*** NOTE***

To install the T9 into the Traverse Unit:

While holding the T9 EPP Keypad on a slight angle, position the keypad notch over the tab on the mounting bracket.



Install the top of the keypad from left to right (from the rear) ensuring the keypad gasket is sitting flush against the control panel. Using slight pressure if needed, ensure the bottom half of the keypad is also sitting flush with the control panel. Secure the keypad with the 6 screws.



Prior to T9 Keypad Activation

The Device Status report will indicate if the EPP has been installed correctly into the unit. This is imperative to check prior to activation as if it is not installed correctly, the EPP activation will fail.

1. Log into Management Functions.
2. If Favorites page appears, press 0 - Main Menu. Press 2 - Diagnostics.
3. Press 8 - Keypad.
4. Press 1 - Device Status.

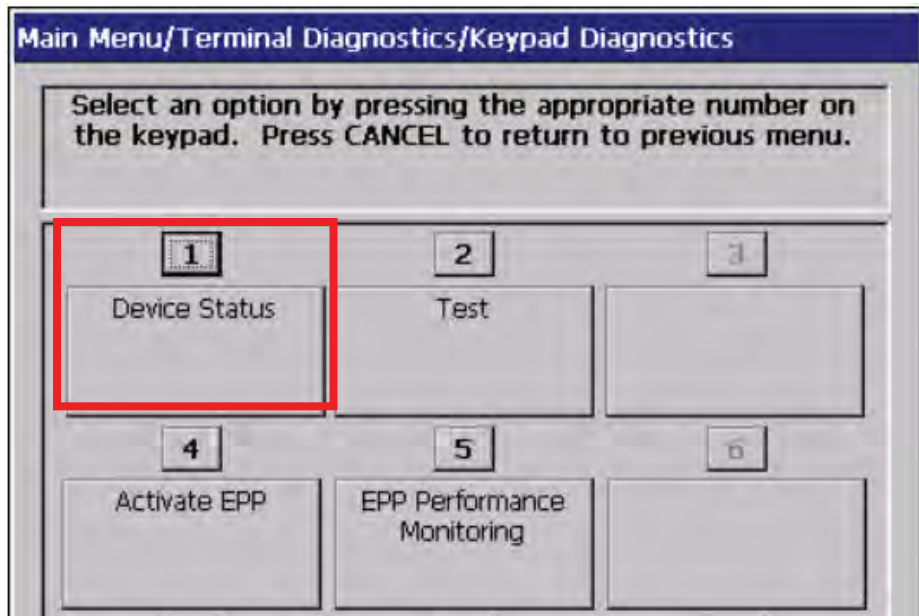

5. If the T9 EPP Keypad has been installed correctly, the “Remove Detector Activated:” will read “TRUE”. If the EPP Keypad is not installed correctly, the “Remove Detector Activated:” will read “FALSE”. If “FALSE”, check that the EPP is correctly aligned in the opening and secured tightly with all six screws.

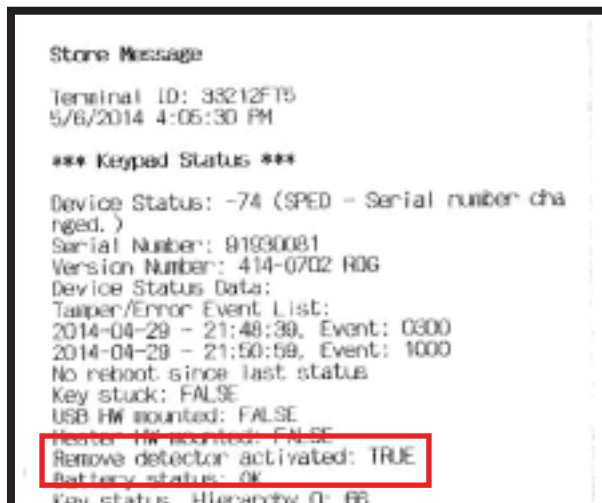

To Activate the T9 Keypad

NOTE: Activation is NOT required for units that ship with the T9 EPP installed.

1. Log into Management Functions.
2. If Favorites page appears, press 0 - Main Menu. Press 2 - Diagnostics.
3. Press 8 - Keypad.
4. Press 4 - Activate EPP.

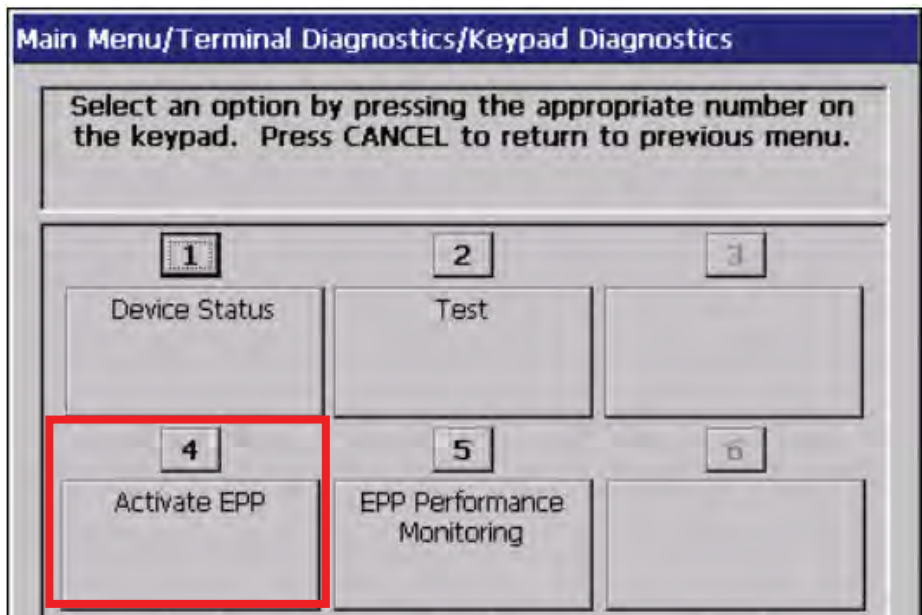

5. When the activation is successful, the “EPP activation successful” message will appear.

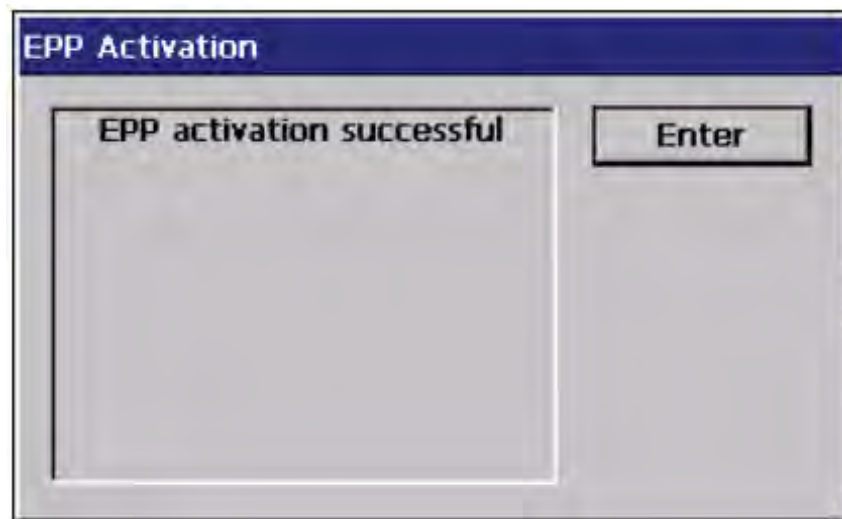

To Reactivate the T9 Keypad

NOTE: Triton Technical Support CANNOT supply an activation code without the Operator Id, Serial Number and Nonce numbers supplied in Step 5.

1. Log into Management Functions.
2. If Favorites page appears, press 0 - Main Menu. Press 2 - Diagnostics.
3. Press 8 - Keypad.
4. Press 4 - Activate EPP.

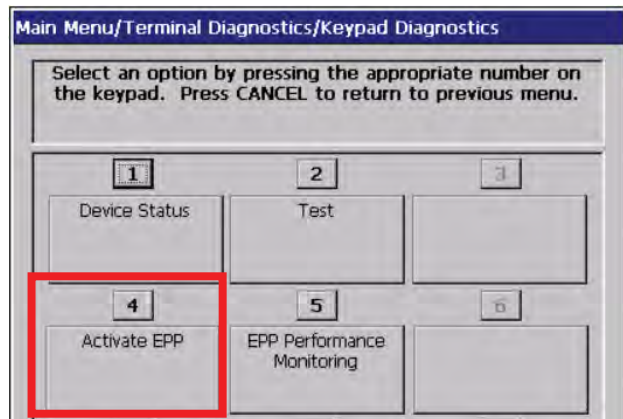

5. The following screen will appear. An activation code is required from Triton Technical Support to reactivate the T9 EPP Keypad. Contact Triton Technical Support with the “Operator Id”, “Serial Number” and “Nonce” numbers (supplied in the EPP Activation dialog box) for an activation code.

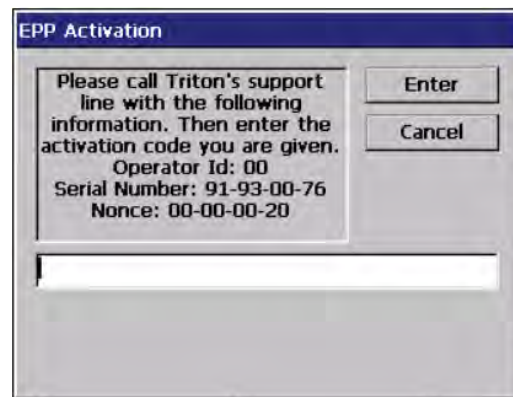

6. Enter the activation code. Press Enter on the keypad. If the code was entered correctly, the “EPP activation successful” box will appear. If the code was entered incorrectly, the “EPP activation failed” box will appear. If failed, repeat steps 4 - 6 (acquire a new code from Triton Technical Support).

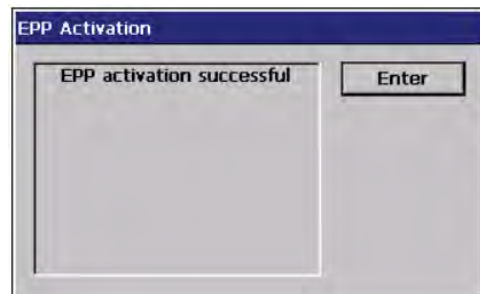
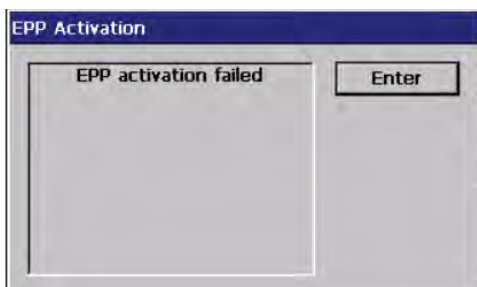

Replacing the battery in the T9 Keypad

NOTE: Do **NOT** remove the battery from the T9 EPP without FIRST connecting a new battery!! This EPP will be permanently damaged if the battery is removed and the keypad is unpowered before connecting a new battery.

1. Shutdown the unit with the proper shutdown procedures. Turn the power switch on the power supply to the OFF (O) position.
2. Remove the battery cover from the EPP. Set the cover aside for reinstallation.



3. **DO NOT UNPLUG CURRENT BATTERY!** Obtain a replacement battery. Plug the new battery into the spare battery connection. The spare battery can be ordered at www.atmgurus.com.

4. After the new battery is correctly installed, unplug and remove the old battery.

5. Secure the new battery in the compartment and reinstall the battery cover.

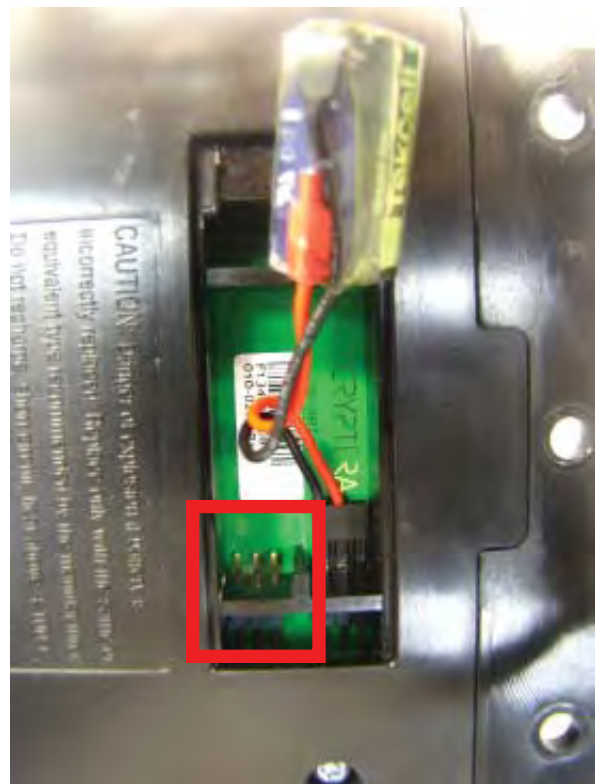

SUPPLEMENT A
T5 AND T7 PCI-EPP
BATTERY REPLACEMENT
PROCEDURES

T5 PCI-EPP BATTERY REPLACEMENT

**** CAUTION ****

You must not remove battery from EPP without FIRST connecting a new battery! This EPP will be permanently damaged if unpowered and battery is removed before connecting a new battery!

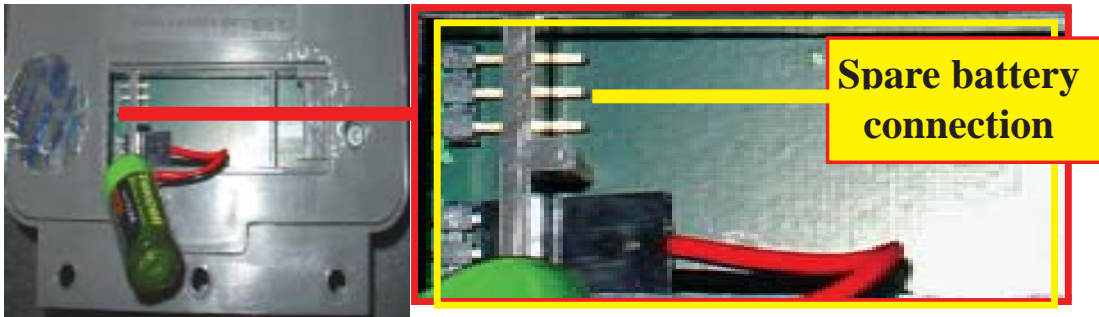

EXISTING BATTERY - DO NOT REMOVE BEFORE CONNECTING A SPARE BATTERY FIRST!

The spare battery for the T5 PCI-EPP may be purchased from
Triton Systems:
P/N 01300-00025 (T5 PCI-EPP Lithium Backup Battery)

T7 PCI-EPP BATTERY REPLACEMENT

*** IMPORTANT***

You may remove the battery without risk of damage to the EPP. You have approximately 2-5 minutes to replace with a spare battery before losing the data stored (keys, passwords) in the keypad.

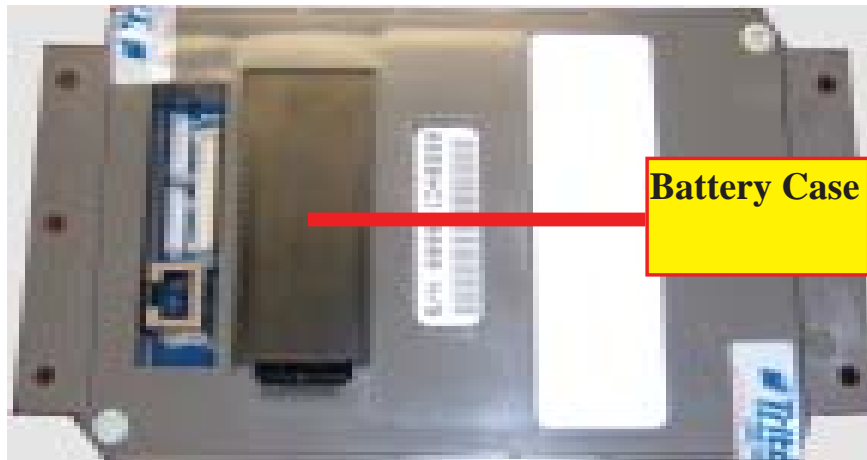

The spare battery for the T7 PCI-EPP may be purchased from Triton Systems:

P/N 01300-00023 (T7 PCI-EPP Lithium Battery)

**THIS PAGE INTENTIONALLY LEFT
BLANK**



T5 PCI-EPP

SUPPLEMENT B
KEY MANAGEMENT
PROCEDURES
T7 PCI-EPP



PCI-EPP (T5) / KEY MANAGEMENT PROCEDURES

DIFFERENCES WITH THE T5 PCI-EPP KEYPAD

1

YOU MUST NOT REMOVE BATTERY FROM EPP WITHOUT FIRST CONNECTING A NEW BATTERY! THIS T5 EPP WILL BE PERMANENTLY DAMAGED IF UNPOWERED AND BATTERY IS REMOVED BEFORE CONNECTING A NEW BATTERY!

2

- **USER PASSWORDS MUST BE AT LEAST 8 CHARACTERS, RATHER THAN 6.**
- **EPP WILL PROMPT WITH ERROR IF FEWER CHARACTERS ENTERED AND THEN TAKE YOU BACK TO PASSWORD ENTRY AT POINT YOU LEFT OFF.**
- **THERE IS NO WAY TO CLEAR THE PASSWORD. HIT <CANCEL> AND START OVER.**

3

- **NO <CLEAR> OR <BACKSPACE> ON KEY ENTRY.**
- **IF ERROR IS MADE IN KEY ENTRY, HIT <CANCEL> AND START KEY ENTRY OVER FROM BEGINNING OF FIRST KEY HALF.**

4

- **YOU MAY ONLY ENTER IN NEW KEYS - NO CHANGE KEY FUNCTIONALITY.**

5

- **YOU HAVE 10 MINUTES TO ENTER IN BOTH USER PASSWORDS BEFORE TIMEOUT.**
 - **IF TIMEOUT OCCURS, YOU MUST START KEY ENTRY OVER FROM SCRATCH.**
 - ***THIS WILL AFFECT STAGING OF UNITS!***
 - **CANNOT ENTER ONE KEY HALF AT WAREHOUSE AND OTHER HALF IN FIELD.**

6

- **PASSWORD ENTRY – CLEAR WILL TAKE YOU BACK TO KEY MANAGEMENT PAGE.**
 - **RE-ENTER PASSWORD.**

SUPPLEMENT B - KEY MANAGEMENT PROCEDURES

KEY MANAGEMENT PROCEDURES (w/T5 PCI-EPP INSTALLED)

① ENTER MANAGEMENT FUNCTIONS > MAIN MENU > KEY MANAGEMENT.

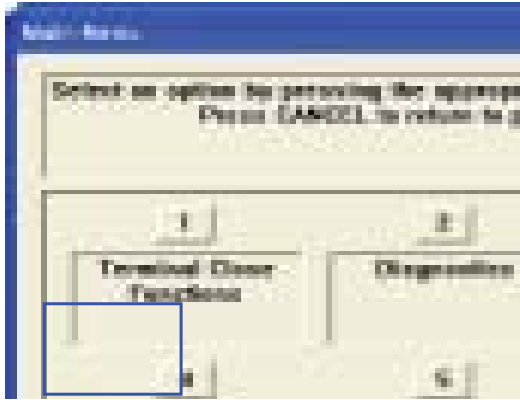

② THE “SET PASSWORD INITIALIZATION” PROMPT APPEARS. PRESS <ENTER>.

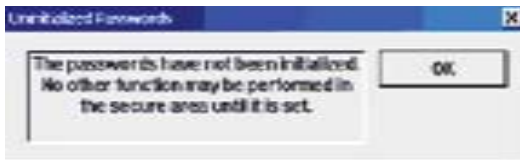

③ SELECT “SET PASSWORD” OPTION.

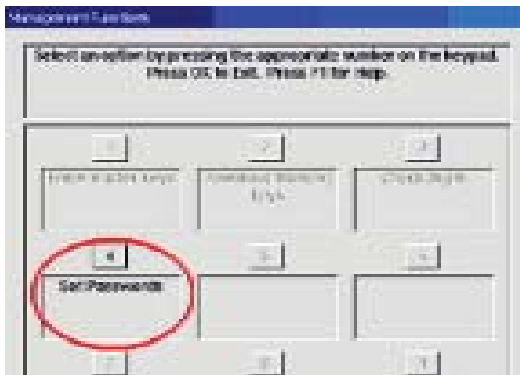

④ *NOTE: PREVIOUSLY, USERS HAD TO ENTER THE INITIAL PASSWORD OF SIX (6) “ZEROS” BEFORE BEING ALLOWED TO SET THE PASSWORDS. THIS IS NO LONGER REQUIRED (FOR T5 PCI-EPP ONLY).*

➤ SELECT “SET USER 1 PASSWORD” OPTION. ENTER NEW PASSWORD FOR USER 1. PASSWORDS CAN BE ANYWHERE FROM ‘8’ TO ‘16’ DECIMAL DIGITS. PRESS <ENTER>.

➤ YOU WILL BE PROMPTED AGAIN TO CONFIRM THE NEW PASSWORD. RE-ENTER NEW PASSWORD. PRESS <ENTER>.

AFTER THE PASSWORD IS INITIALIZED, THE “SET USER 1 PASSWORD” OPTION CHANGES TO “CHANGE USER 1 PASSWORD”.

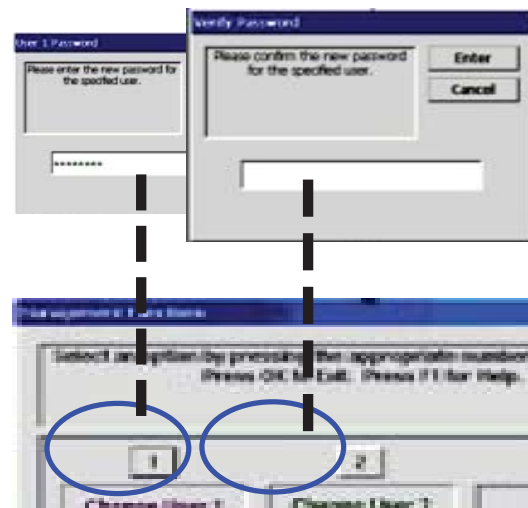

➤ NEXT, SELECT “SET USER 2 PASSWORD” OPTION. FOLLOW THE SAME PROCEDURE FOR ENTERING A NEW PASSWORD FOR USER 2.

WHEN COMPLETED, THE “SET USER 2 PASSWORD” OPTION WILL CHANGE TO “CHANGE USER 2 PASSWORD”.

AFTER COMPLETION, HIT <CANCEL> TO ENTER MASTER KEYS SCREEN (STEP 5).

⑤ SELECT “ENTER MASTER KEYS” OPTION.

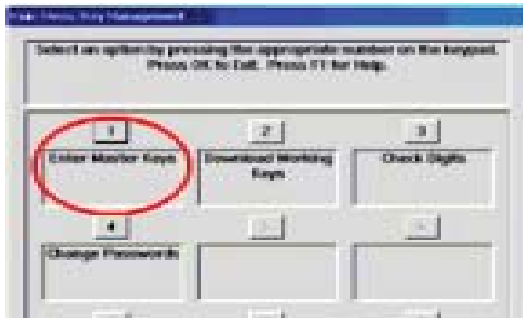

IMPORTANT: THE REST OF THE PROCEDURES MUST BE COMPLETED WITHIN A 10 MINUTE PERIOD. IF THE PROCESS TAKES LONGER THAN THAT, THE KEY PARTS WILL NOT BE ABLE TO BE COMBINED!

⑥ ENTER USER 1 PASSWORD. PRESS <ENTER>.

ENTER USER 2 PASSWORD. PRESS <ENTER>.

⑦ SELECT “ENTER PIN MASTER KEY” OPTION.

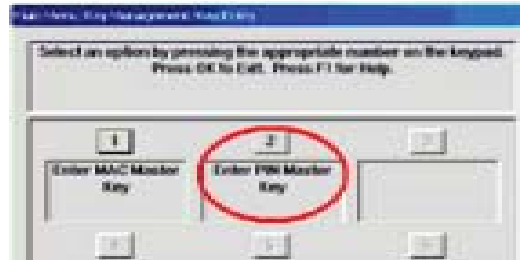
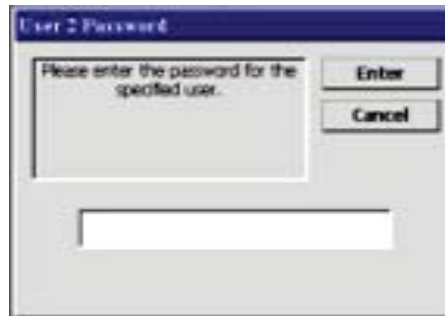

⑧ USER 1 ENTERS THE FIRST KEY PART (32 CHARACTERS). REFERENCE THE KEY LAYOUT DISPLAY BELOW. THE MAIN KEY-PAD WILL MIRROR THE NUMBER/ALPHANUMERIC KEYS.

AFTER ENTERING THE KEYS, PRESS THE <ENTER> OPTION ON THE RIGHT-SIDE FUNCTION KEY <F7>.

SUPPLEMENT B - KEY MANAGEMENT PROCEDURES

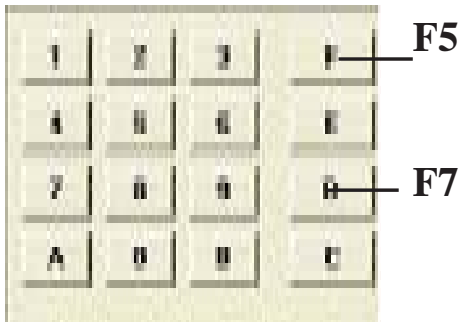
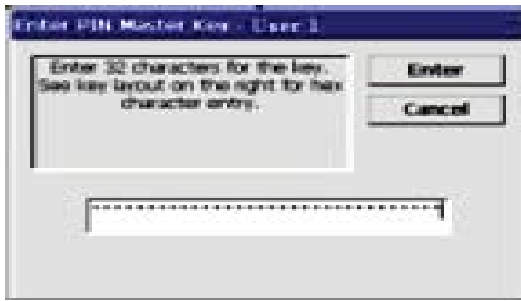

⑨ THE “CHECK DIGITS” PROMPT APPEARS. PRESS <ENTER>.

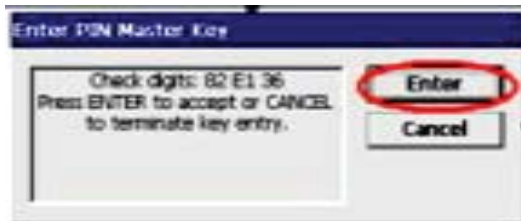

A PROMPT APPEARS TO ENTER THE SECOND KEY PART. PRESS <ENTER>.

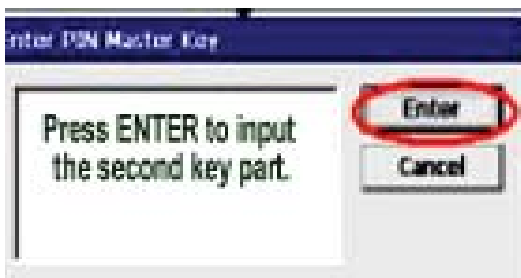

⑩ USER 2 ENTERS THE SECOND KEY PART (32 CHARACTERS). REFER TO STEP 8 FOR ENTERING KEYS.



⑪ THE “CHECK DIGITS” PROMPT APPEARS.

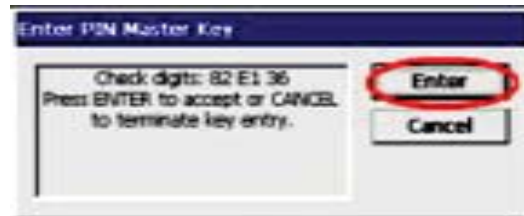

YOU WILL BE PROMPTED THAT THE KEY WAS SUCCESSFULLY CHANGED.



REPEAT SEQUENCE FOR ENTERING MAC MASTER KEY, IF REQUIRED.

KEY MANAGEMENT PROCEDURES (w/T7 PCI-EPP INSTALLED)

① **ENTER MANAGEMENT FUNCTIONS > MAIN MENU > KEY MANAGEMENT.**

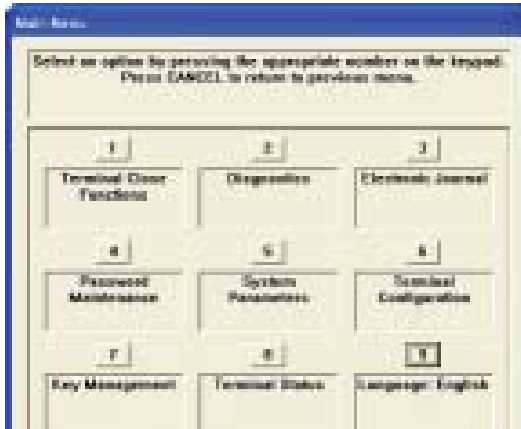

② **THE “SET PASSWORD INITIALIZATION” PROMPT APPEARS. PRESS <ENTER>.**

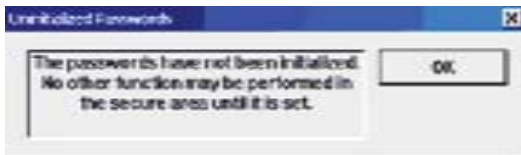

③ **SELECT “SET PASSWORD” OPTION.**

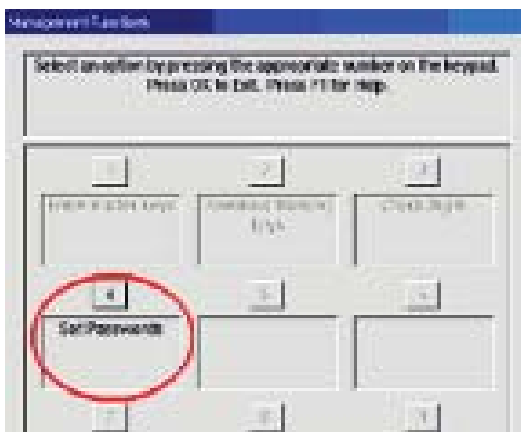

④ **THE T7 USER PASSWORDS ARE INITIALLY SET TO SIX (6) “ZEROS (SIMILAR TO VEPP) BEFORE BEING ALLOWED TO SET THE PASSWORDS.**

➤ **SELECT “SET USER 1 PASSWORD” OPTION. ENTER NEW PASSWORD FOR USER 1. PASSWORDS CAN BE ANYWHERE FROM ‘6’ TO ‘14’ DECIMAL DIGITS. PRESS <ENTER>.**

➤ **YOU WILL BE PROMPTED AGAIN TO CONFIRM THE NEW PASSWORD. RE-ENTER NEW PASSWORD. PRESS <ENTER>.**

AFTER THE PASSWORD IS INITIALIZED, THE “SET USER 1 PASSWORD” OPTION CHANGES TO “CHANGE USER 1 PASSWORD”.

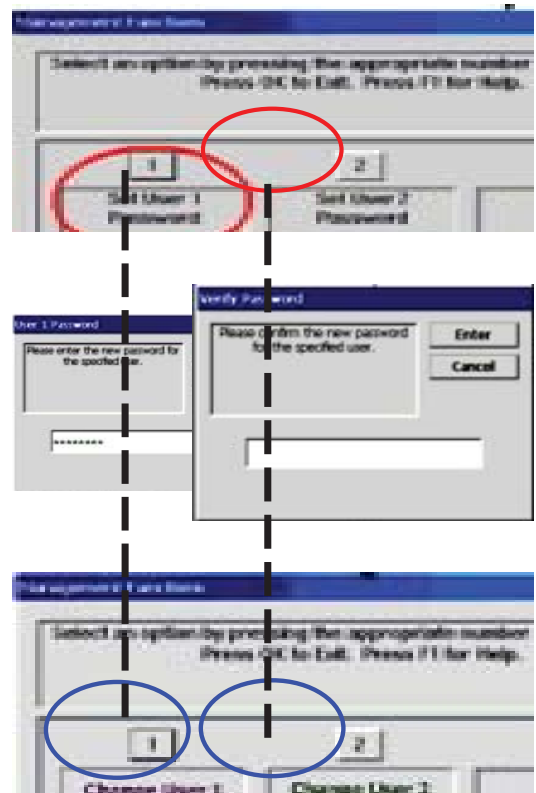

SUPPLEMENT B - KEY MANAGEMENT PROCEDURES

➤ NEXT, SELECT “SET USER 2 PASSWORD” OPTION. FOLLOW THE SAME PROCEDURE FOR ENTERING A NEW PASSWORD FOR USER 2.

WHEN COMPLETED, THE “SET USER 2 PASSWORD” OPTION WILL CHANGE TO “CHANGE USER 2 PASSWORD”.

AFTER COMPLETION, HIT <CANCEL> TO ENTER MASTER KEYS SCREEN (STEP 5).

⑤ SELECT “ENTER MASTER KEYS” OPTION.

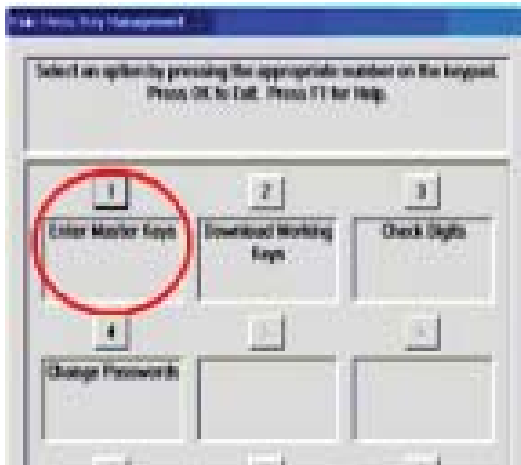

⑥ ENTER USER 1 PASSWORD.
PRESS <ENTER>.
ENTER USER 2 PASSWORD.
PRESS <ENTER>.

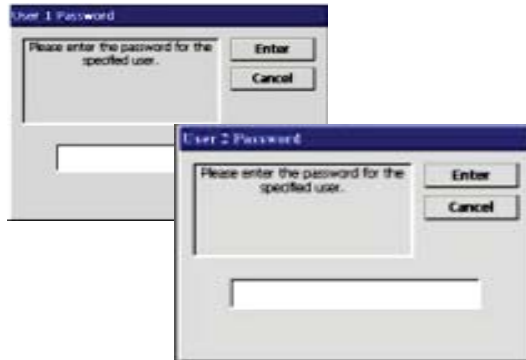

⑦ SELECT “ENTER PIN MASTER KEY” OPTION.

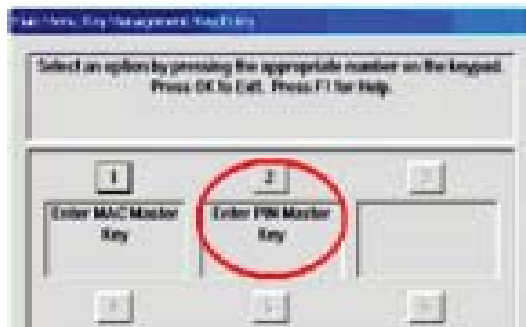

⑧ USE THE <ARROW> KEY TO TOGGLE BETWEEN “NEW KEY” OR “ADD PART” (TO AN EXISTING KEY).

PRESS <ENTER> FOR THE APPLICABLE ENTRY.

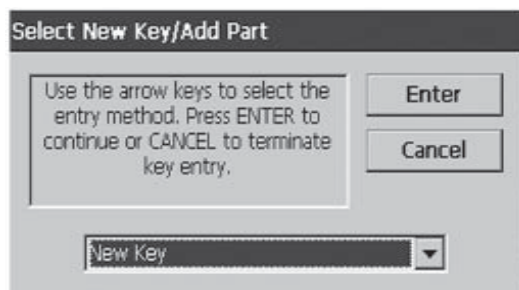

⑨ **USER 1 ENTERS THE FIRST KEY PART (32 CHARACTERS). REFERENCE THE KEY LAYOUT DISPLAY BELOW. THE MAIN KEY-PAD WILL MIRROR THE NUMBER/ALPHANUMERIC KEYS.**

AFTER ENTERING THE KEYS, PRESS THE <ENTER> OPTION ON THE RIGHT-SIDE FUNCTION KEY <F7>.

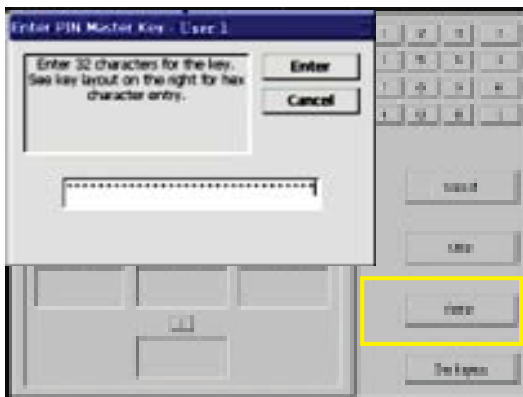

⑩ **THE “CHECK DIGITS” PROMPT APPEARS. PRESS <ENTER>.**

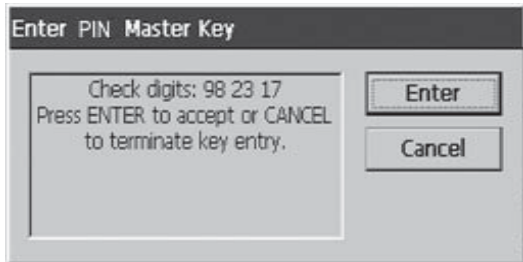

A PROMPT APPEARS TO ENTER THE SECOND KEY PART. PRESS <ENTER>.



⑪ **USER 2 ENTERS THE SECOND KEY PART (32 CHARACTERS). REFER TO STEP 9 FOR ENTERING KEYS.**

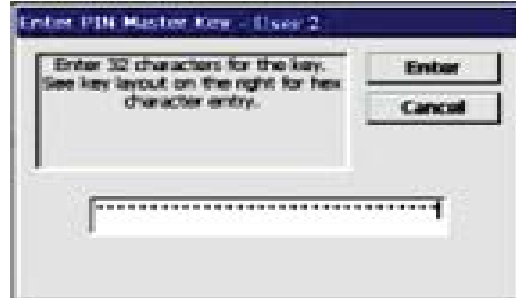

⑫ **THE “CHECK DIGITS” PROMPT APPEARS.**



YOU WILL BE PROMPTED THAT THE KEY WAS SUCCESSFULLY CHANGED.

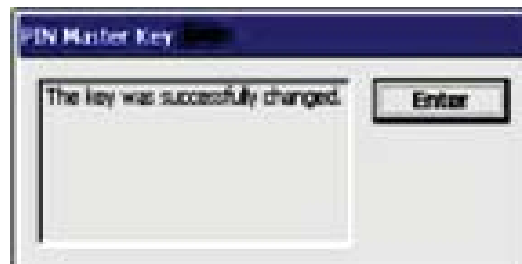

REPEAT SEQUENCE FOR ENTERING MAC MASTER KEY , IF REQUIRED.